



PS 300

English



# PS 300

Original operating instructions



## Contents

<b>1</b>	<b>Information about the documentation</b>	<b>3</b>
1.1	About this documentation	3
1.2	Explanation of symbols used	3
1.2.1	Warnings	3
1.2.2	Symbols in the documentation	3
1.2.3	Symbols in the illustrations	4
1.3	Product-dependent symbols	4
1.3.1	Symbols on the product	4
1.4	Text markings	4
1.4.1	Buttons / software	4
1.5	Declaration of conformity	4
1.6	Product information	4
<b>2</b>	<b>Safety</b>	<b>5</b>
2.1	General safety instructions, scanning tools	5
2.2	Battery use and care	5
2.3	Additional safety instructions, detectors	6
<b>3</b>	<b>Description</b>	<b>9</b>
3.1	Overview	9
3.2	Overview, main menu	10
3.3	Overview, 'Quickscan' / 'Quickscan Rec.'	10
3.4	Intended use	11
3.5	Limitations of use	11
3.6	Restrictions on scanning performance	11
3.7	Detection range, measurement range and accuracy	11
3.8	Items supplied	12
<b>4</b>	<b>Technical data</b>	<b>12</b>
4.1	Technical data	12
4.2	Battery	13
<b>5</b>	<b>Before use</b>	<b>13</b>
5.1	Charging the battery	13
5.2	Inserting the battery	13
5.3	Switching on the scanning tool	13
5.4	Starting for the first time	13
<b>6</b>	<b>Operation</b>	<b>13</b>
6.1	Functions of the buttons	13
6.1.1	One-handed operation	14
6.2	Touchscreen	14
6.3	Displaying the operating instructions	15
6.4	Status area	15
6.5	Information area	15
6.6	Functions	15
6.6.1	Calibrate	16
6.7	Switching off the scanning tool	16
6.8	Removing the battery	16

<b>7</b>	<b>'Quickscan'</b> .....	<b>16</b>
7.1	<b>'Quickscan'</b> analysis .....	18
7.1.1	<b>'Parameters'</b> .....	19
7.1.2	<b>'Visualization'</b> .....	20
7.1.3	Selecting a scanning path .....	20
7.1.4	Depth filter .....	21
7.1.5	Viewing <b>'Statistics'</b> .....	21
<b>8</b>	<b>'Quickscan Rec.'</b> .....	<b>22</b>
8.1	Selecting scan direction .....	23
8.2	<b>'Quickscan Rec.'</b> analysis .....	24
8.2.1	Setting, editing and deleting <b>'Markers'</b> .....	26
8.2.2	<b>'Parameters'</b> .....	27
8.2.3	<b>'Visualization'</b> .....	27
8.2.4	Selecting a scanning path .....	28
8.2.5	Depth filter .....	28
8.2.6	Viewing <b>'Statistics'</b> .....	29
<b>9</b>	<b>'Imagescan'</b> .....	<b>30</b>
9.1	<b>'Imagescan'</b> Preview .....	31
9.2	Setting, editing and deleting <b>'Markers'</b> .....	32
<b>10</b>	<b>'Projects'</b> .....	<b>33</b>
10.1	Creating a new project .....	33
10.2	Retrieving and editing project information .....	34
10.3	Activating project .....	34
10.4	Deleting projects .....	35
10.5	Data transfer .....	35
10.6	Managing scans .....	36
10.7	Editing the name of a scan .....	36
10.8	Move scan to another project .....	37
10.9	Deleting scans .....	37
<b>11</b>	<b>Settings</b> .....	<b>38</b>
11.1	The <b>'Settings'</b> menu .....	38
11.1.1	<b>'Brightness'</b> .....	38
11.1.2	<b>'Volume'</b> .....	38
11.1.3	<b>'Date / Time'</b> .....	39
11.1.4	<b>'Country settings'</b> .....	39
11.1.5	<b>'Power mode'</b> .....	40
11.1.6	<b>'Options'</b> .....	40
11.1.7	<b>'Info'</b> .....	41
11.1.8	<b>'Factory Reset'</b> .....	41
11.1.9	<b>'Update'</b> .....	41
11.1.10	Travel-sensor test .....	43
<b>12</b>	<b>Optional accessories</b> .....	<b>43</b>
12.1	Using the PS 300 with the PSA 71 telescopic extension (accessory) .....	43
<b>13</b>	<b>Tips and tricks</b> .....	<b>43</b>
13.1	General .....	43
13.2	Deep objects .....	44
13.3	Non-welded reinforcement structures .....	44
13.4	Reinforcement structures with significantly different diameters .....	45
13.5	Reinforcement structures with single and double reinforcement .....	45

13.6	Reinforcement structures with significant differences in cover or upright reinforcing bars . . . . .	46
13.7	Welded reinforcement meshes . . . . .	46
13.8	Special objects or configurations . . . . .	46
<b>14</b>	<b>Transport and storage of cordless tools . . . . .</b>	<b>47</b>
14.1	Care and maintenance . . . . .	47
14.2	HiltiMeasuring Systems Service . . . . .	47
<b>15</b>	<b>Troubleshooting . . . . .</b>	<b>48</b>
15.1	Troubleshooting . . . . .	48
<b>16</b>	<b>RoHS (Restriction of Hazardous Substances) . . . . .</b>	<b>49</b>
<b>17</b>	<b>Disposal . . . . .</b>	<b>49</b>
<b>18</b>	<b>Manufacturer's warranty . . . . .</b>	<b>50</b>
<b>19</b>	<b>FCC statement (applicable in US) / IC statement (applicable in Canada) . . . . .</b>	<b>50</b>
<b>20</b>	<b>Tolerances of reinforcing bars . . . . .</b>	<b>50</b>

## 1 Information about the documentation

### 1.1 About this documentation

- Read this documentation before initial operation or use. This is a prerequisite for safe, trouble-free handling and use of the product.
- Observe the safety instructions and warnings in this documentation and on the product.
- Always keep the operating instructions with the product and make sure that the operating instructions are with the product when it is given to other persons.

### 1.2 Explanation of symbols used

#### 1.2.1 Warnings

Warnings alert persons to hazards that occur when handling or using the product. The following signal words are used:

#### **DANGER**

##### **DANGER !**

- ▶ Draws attention to imminent danger that will lead to serious personal injury or fatality.

#### **WARNING**

##### **WARNING !**

- ▶ Draws attention to a potential threat of danger that can lead to serious injury or fatality.





#### **CAUTION**

##### **CAUTION !**

- ▶ Draws attention to a potentially dangerous situation that could lead to slight personal injury or damage to the equipment or other property.

#### 1.2.2 Symbols in the documentation

The following symbols are used in this document:

	Read the operating instructions before use.
	Instructions for use and other useful information
	Dealing with recyclable materials
	Do not dispose of electric equipment and batteries as household waste

### 1.2.3 Symbols in the illustrations

The following symbols are used in illustrations:

	These numbers refer to the corresponding illustrations found at the beginning of these operating instructions
3	The numbering reflects the sequence of operations shown in the illustrations and may deviate from the steps described in the text
	Item reference numbers are used in the <b>overview illustrations</b> and refer to the numbers used in the <b>product overview section</b>
	This symbol is intended to draw special attention to certain points when handling the product.

## 1.3 Product-dependent symbols

### 1.3.1 Symbols on the product

The following symbols can be used on the product:

	Wireless data transfer
	<b>Hilti</b> Li-ion battery type series used. Observe the information given in the section headed <b>Intended use</b> .
	The product can present hazards. Read the operating instructions.

## 1.4 Text markings

### 1.4.1 Buttons / software

The following text markings are used in this documentation:

	Buttons as text labels have a <b>gray background</b> .
	Button as symbols have a black background.
	Buttons and on-screen symbols have a light background.
'...'	On-screen texts are in bold and inside <b>'single quotes'</b> .

## 1.5 Declaration of conformity

We declare, on our sole responsibility, that the product described here complies with the applicable directives and standards. A copy of the declaration of conformity and other regulatory marks of approval can be found at the end of this documentation.

The technical documentation is filed and stored here:

**Hilti** Entwicklungsgesellschaft mbH | Tool Certification | Hiltistrasse 6 | 86916 Kaufering, Germany

## 1.6 Product information

products are designed for professional users and only trained, authorized personnel are permitted to operate, service and maintain the products. This personnel must be specifically informed about the possible hazards. The product and its ancillary equipment can present hazards if used incorrectly by untrained personnel or if used not in accordance with the intended use.

The type designation and serial number are printed on the rating plate.

- Write down the serial number in the table below. You will be required to state the product details when contacting Hilti Service or your local Hilti organization to inquire about the product.

### Product information

Scanner	PS 300   PS 300-W
Generation	01
Serial no.	



## 2 Safety

### 2.1 General safety instructions, scanning tools

**⚠ WARNING! Read all safety precautions and other instructions.** Failure to observe the safety instructions and other instructions can result in electric shock, fire and/or serious injury.

Keep all safety precautions and instructions for future reference.

#### Work area safety

- ▶ **Keep your workplace clean and well lit.** Cluttered or poorly lit workplaces invite accidents.
- ▶ Do not operate the product in explosive atmospheres, such as in the presence of flammable liquids, gases or dust. Scanning tools create sparks which can ignite dust, fumes or vapors.
- ▶ **Keep children and other persons clear when the product is in use.** Distractions can cause you to lose control of the product.

#### Electrical safety

- ▶ Do not expose the product to rain or moisture. Water entering the product will increase the risk of electric shock.

#### Personal safety

- ▶ **Stay alert, watch what you are doing and use common sense when operating a scanning tool.** Do not use a scanning tool while you are tired or under the influence of drugs, alcohol or medication. A moment of inattention while operating the scanning tool can result in serious personal injury.
- ▶ **Adopt the correct posture when working. Maintain proper footing and balance at all times.** This will allow you to control the scanning tool better, even in unexpected situations.
- ▶ **Wear your personal protective equipment and always wear protective glasses.** Depending on the type of scanning tool you are using and its purpose, wearing safety equipment such as a dust mask, slip-resistant safety shoes, a hard hat or hearing protection will reduce the risk of injury.
- ▶ **Avoid starting the tool accidentally. Make sure that the scanning tool is switched off before connecting it to the battery and before picking it up or carrying it.** Carrying scanning tools with your finger on the switch or plugging in scanning tools that are already switched on can cause accidents.

#### Using and handling the scanning tool

- ▶ **Do not use a scanning tool if it has a faulty on/off switch.** A scanning tool that can no longer be switched on or off is dangerous and must be repaired.
- ▶ Store scanning tools out of reach of children when not in use. Do not allow persons who are not familiar with the product or these instructions to operate it. Scanning tools are dangerous in the hands of inexperienced persons.
- ▶ **Scanning tools need care and attention.** Check that moving parts operate satisfactorily and do not jam, and make sure that no parts are broken or damaged in such a way that the scanning tool might no longer function correctly. Have damaged parts repaired before using the scanning tool. Many accidents are caused by poorly maintained scanning tools.

#### Using and handling the cordless power tool

- ▶ **Use only the specified batteries in the scanning tools.** Use of other batteries can result in injury and a risk of fire.
- ▶ **Recharge only with the charger specified by the manufacturer.** A charger that is suitable for a certain type of battery may present a risk of fire when used with other types of battery.
- ▶ **When the battery is not in use, keep it away from other metal objects such as paper clips, coins, keys, nails, screws, or other small metal objects that could cause bridging between the terminals.** A short circuit between the battery terminals may cause burns or a fire.
- ▶ **Liquid may leak from the battery if used incorrectly. Avoid contact with this liquid.** Liquid leaking from the battery may cause skin irritation or burns. If contact accidentally occurs, rinse with water. Seek medical attention if the liquid comes into contact with the eyes.

### 2.2 Battery use and care

- ▶ Observe the special regulations and instructions applicable to the transport, storage and use of Li-ion batteries.
- ▶ Do not expose batteries to high temperatures, direct sunlight or fire.
- ▶ Do not disassemble, crush or incinerate batteries and do not subject them to temperatures over 80 °C.
- ▶ Do not use or charge batteries that have suffered mechanical impact, have been dropped from a height or show signs of damage. In this case, always contact your **Hilti Service**.

- ▶ If the battery is too hot to touch it may be defective. In this case, place the product in a non-flammable location, well away from flammable materials, where it can be kept under observation and allowed to cool down. In this case, always contact your **Hilti Service**.

### 2.3 Additional safety instructions, detectors

- ▶ This product complies with all the requirements of the applicable directives, but **Hilti** cannot entirely rule out the possibility of interference caused by powerful magnetic or electromagnetic fields affecting it, possibly leading to incorrect measurements. Check accuracy by taking measurements by other means when working under such conditions, or if you are unsure.
- ▶ Before using the scanning tool, read the operating instructions stored in its memory.
- ▶ Use the scanning tool only when it is in perfect working order.
- ▶ Never tamper with or modify the scanning tool in any way.
- ▶ Do not operate the scanning tool in proximity to pregnant women or users of cardiac pacemakers or in the vicinity of medical apparatus.
- ▶ Acclimatize the scanning tool before using it.
  - ↳ Big differences in temperature can lead to incorrect operation.
- ▶ Rapidly changing detection conditions may lead to inaccurate readings.
- ▶ Prior to use, always check the scanning tool's presettings and the settings you have made yourself.
- ▶ Comply with warnings if they are issued.
- ▶ Attach the reference grid securely and, when necessary, use the given corner positions of the grid to mark the corner points on the concrete surface.
- ▶ Due to the scanning principle employed, the results of the scan may be negatively affected by certain ambient conditions. These include, e.g. proximity to devices that generate powerful magnetic or electromagnetic fields, dampness, construction materials containing metal, aluminum foil-backed insulation, multiple layers, materials with cavities or electrically conductive wall coverings or tiles. Accordingly, other sources of information (e.g. plans of the building) should also be consulted before beginning drilling, sawing or grinding in the area scanned.
- ▶ Never rely on the scanning tool alone. Verify the results of scans by cross-checking with other sources of information and by taking control measurements and, if necessary, by drilling pilot holes.
- ▶ Do not drill at positions where the scanning tool has detected the presence of an object. Take the diameter of the drill bit into account and always allow an adequate safety factor.
- ▶ Keep the underside of the scanner and the wheels clean as these parts can have an influence on scanning accuracy.
- ▶ While scanning is in progress, always keep all 4 wheels in contact with the surface being scanned. Do not scan over steps or edges.
- ▶ Do not affix stickers or adhesive labels to the sensor area at the back of the scanning tool. Metal plates / labels, in particular, will affect scanning results.
- ▶ Use only a clean, dry finger to operate the touchscreen. Wipe the touchscreen with a clean, non-abrasive cloth so that it is shiny and responsive to the touch. Dry the scanning tool before stowing it in a transport container.
- ▶ The specified operating and storage temperatures must be observed.
- ▶ Remove the battery prior to storage.
- ▶ Check the accuracy of the scanning tool if it has been dropped or subjected to other mechanical stresses. If the device is damaged, have it repaired by a **Hilti** service center.
- ▶ The scanning tool is designed for the tough conditions of jobsite use, but as with other optical and electronic instruments (e.g. binoculars, spectacles, cameras) it must be handled with care.
- ▶ Comply with the national accident prevention regulations.





### 3 Description

#### 3.1 Overview

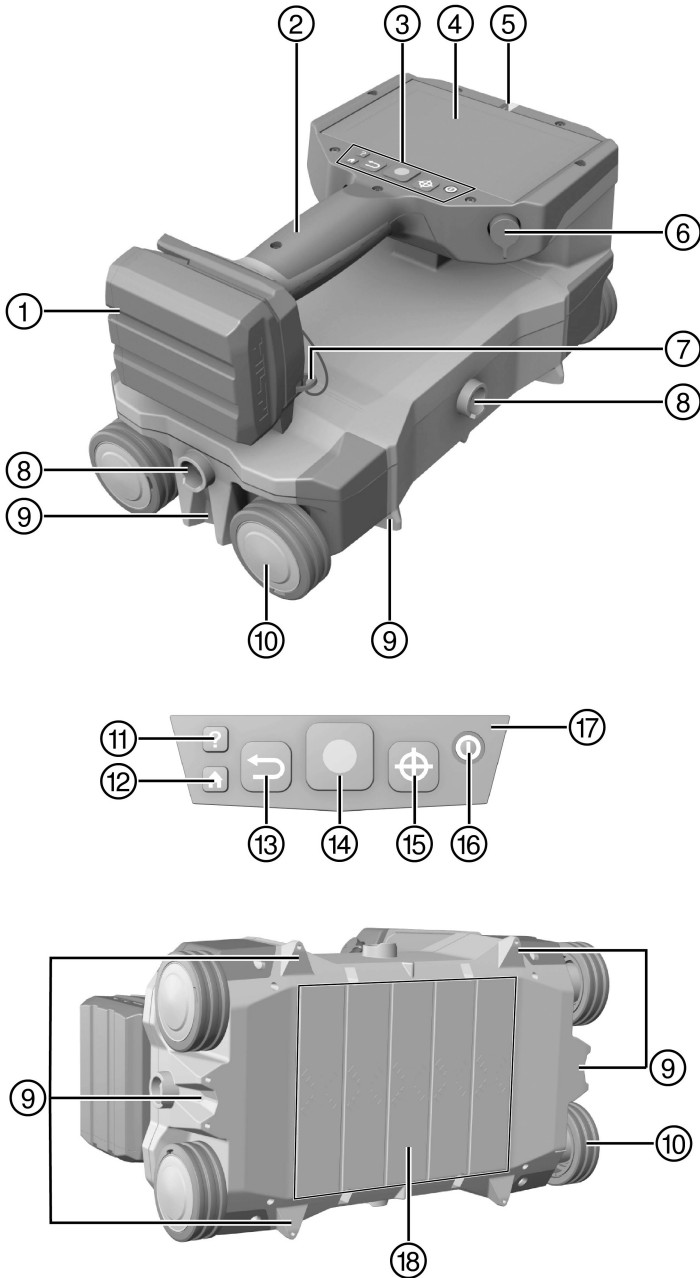

\*\*\*\*\* For internal use only \*\*\*\*\* 26.03.2019 / 13:37:37 - H2DOK-Projekt\System\PS\_300-G1\ENU\PS300\_lang

- |   |                              |
|---|------------------------------|
| ① Battery   | ⑩ Wheels                     |
| ② Grip  | ⑪ <b>Help</b> button         |
| ③ Control panel                                     | ⑫ <b>Home</b> button         |
| ④ Touch-sensitive screen                            | ⑬ <b>Back</b> button         |
| ⑤ Object indicator                                  | ⑭ <b>Start / Stop</b> button |
| ⑥ Multifunction port                                | ⑮ <b>Mark</b> button         |
| ⑦ Hand strap  | ⑯ <b>On / Off</b> button     |
| ⑧ Attachment points for PSA 71 telescopic extension | ⑰ LED status indicator       |
| ⑨ Marking notches / projections                     | ⑱ Sensor area                |

### 3.2 Overview, main menu

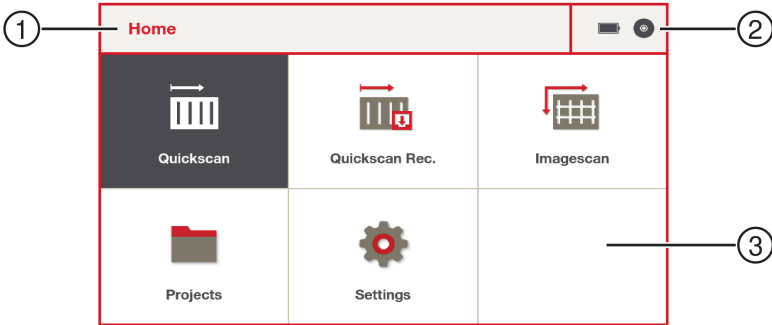

- |               |                           |
|---------------|---------------------------|
| ① Title bar   | ③ Main area of the screen |
| ② Status area |                           |

### 3.3 Overview, 'Quickscan' / 'Quickscan Rec.'

What you see on the display varies, depending on which function is selected.

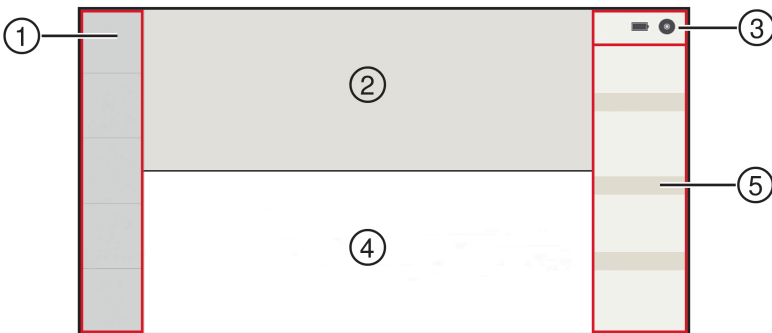

- |                           |                                |
|---------------------------|--------------------------------|
| ① Functions               | ④ Progress bar / cross section |
| ② Preview area / top view | ⑤ Information area             |
| ③ Status area             |                                |

### 3.4 Intended use

This scanning tool is designed for locating reinforcing bars in concrete and other non-ferritic construction materials, and for measuring the cover and estimating the diameter of the topmost layer of the reinforcement.

- ▶ Use only **Hilti** Li-ion batteries of the B 12 series with this product.
- ▶ Use only **Hilti** battery chargers of the C4/12 series for charging these batteries.

### 3.5 Limitations of use

The scanning tool complies with the limit values specified for electromagnetic compatibility and the wireless spectrum. Nevertheless, permission must be obtained prior to operating the scanning tool at locations such as hospitals and nuclear power plants, or in proximity to airports and cellular telephone relay stations.

### 3.6 Restrictions on scanning performance

**Due to the scanning principle employed, certain unfavorable circumstances may affect the result:**

- Surface is uneven or rough.
- Reinforcing bars are corroded.
- Reinforcing bars are welded.
- Adjacent reinforcing bars differ in diameter or are at different depths.
- Reinforcing bars are not normal to or parallel with the scanning direction or are not parallel with the surface.
- Reinforcing bars have a relative magnetic permeability outside the 85-105 range.
- Ferromagnetic or paramagnetic objects close to reinforcing bars.
- Ferromagnetic or paramagnetic aggregates in construction materials on which scans are taken.
- External sources of electromagnetic interference (e.g. transformers, switches in strong electrical circuits).
- Electromagnetic emitters (other devices, including other scanners) less than 2 meters (6.6 ft) from the scanning tool.
- Interference from external magnetic fields or nearby objects with magnetic properties.
- Metallic covers, insulation with aluminum foil backing, or comparable materials on the surface to be scanned.
- Scanner's wheels are dirty.
- Not all 4 wheels running on the surface to be scanned.



See the section headed "Tips and tricks" for ways of solving certain difficulties and obtaining better results from your scans. → page 43

### 3.7 Detection range, measurement range and accuracy

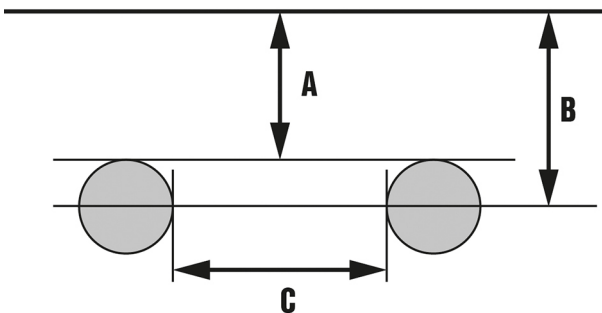

The minimum spacing between two reinforcing bars is 30 mm (1.18 in).

The ratio between spacing (C) of the reinforcing bars and cover (A) must be at least 1.2 : 1. Example: If the spacing is 120 mm, cover has to be at least 100 mm.

If the spacing is closer and/or the ratio of spacing to cover is smaller, the objects cannot be recognized as separate reinforcing bars.

The displayed depth (B) of the objects is the shortest distance from the object to the surface of the encasing construction material. In the case of circular-section reinforcing bars, it is the middle of the object.

See the section headed "Tolerances for reinforcing bars" for more information about the accuracy of cover measurement. → page 50

### 3.8 Items supplied

PS 300 detector, wrist strap, data-storage medium, data cable, brush, cleaning cloth, reference grid, adhesive tape, marker pen, operating instructions, case.

Other system products approved for use with this product can be found at your local **Hilti Store** or at: [www.hilti.group](http://www.hilti.group) | USA: [www.hilti.com](http://www.hilti.com)

## 4 Technical data

### 4.1 Technical data

	PS 300	PS 300-W
<b>Maximum depth for measurement of coverage</b>	200 mm (7.9 in)	200 mm (7.9 in)
<b>Accuracy of localization</b>	1 % +/- 3 mm (0.12 in)	1 % +/- 3 mm (0.12 in)
<b>Accuracy of cover measurement to a depth ≤ 50 mm (1.97 in).</b>	+/- 1 mm (0.04 in)	+/- 1 mm (0.04 in)
<b>Rebar diameter</b>	4 mm ... 57 mm (0.2 in ... 2.2 in)	4 mm ... 57 mm (0.2 in ... 2.2 in)
<b>Battery life under normal operating conditions</b>	4 h	4 h
<b>Maximum scanning speed</b>	0.50 m/s (1.64 ft/s)	0.50 m/s (1.64 ft/s)
<b>Memory type</b>	Built-in flash memory	Built-in flash memory
<b>Memory capacity</b>	3 GB	3 GB
<b>Data interface</b>	USB	USB, WiFi
<b>Data transfer rate</b>	Typically 4 Mbyte/s	Typically 4 Mbyte/s
<b>Weight</b>	1.95 kg (4.30 lb)	1.95 kg (4.30 lb)
<b>Dimensions</b>	284 x 163 x 154 mm (11.18 x 6.42 x 6.06 in)	284 x 163 x 154 mm (11.18 x 6.42 x 6.06 in)
<b>Display type</b>	LCD	LCD
<b>Display size</b>	134.8 x 90.6 mm (5.31 x 3.57 in)	134.8 x 90.6 mm (5.31 x 3.57 in)
<b>Display resolution</b>	800 x 480 pixels	800 x 480 pixels
<b>Degree of protection, without battery</b>	IP 54	IP 54
<b>Relative air humidity</b>	90 %	90 %
<b>Ambient temperature for operation</b>	-10 °C ... 50 °C (14 °F ... 122 °F)	-10 °C ... 50 °C (14 °F ... 122 °F)
<b>Storage temperature</b>	-25 °C ... 63 °C (-13 °F ... 145 °F)	-25 °C ... 63 °C (-13 °F ... 145 °F)
<b>WiFi frequency, channels 1-11</b>	•/•	2,412 MHz ... 2,462 MHz
<b>WiFi frequency, channels 36-48</b>	•/•	5,180 MHz ... 5,240 MHz
<b>Maximum emitted transmission power, channels 1-11</b>	•/•	100 mW
<b>Maximum emitted transmission power, channels 36-48</b>	•/•	50 mW



## 4.2 Battery

<b>Battery operating voltage</b>	10.8 V
<b>Ambient temperature for operation</b>	-17 °C ... 60 °C (1 °F ... 140 °F)
<b>Storage temperature</b>	-20 °C ... 40 °C (-4 °F ... 104 °F)
<b>Battery charging starting temperature</b>	-10 °C ... 45 °C (14 °F ... 113 °F)

## 5 Before use

### 5.1 Charging the battery

1. Before charging the battery, read the operating instructions for the charger.
2. Make sure that the contacts on the battery and the contacts on the charger are clean and dry.
3. Use an approved charger to charge the battery.

### 5.2 Inserting the battery

#### CAUTION

#### Risk of injury by short circuit or falling battery!

- ▶ Before inserting the battery, make sure that the contacts on the battery and the contacts on the product are free of foreign matter.
- ▶ Make sure that the battery always engages correctly.

1. Charge the battery fully before using it for the first time.
2. Push the battery into the battery holder until it engages with an audible click.
3. Check that the battery is seated securely.

### 5.3 Switching on the scanning tool

1. Press the button.
2. The **'Accept disclaimer'** message appears on the display. You must accept the terms of this notice shown in order to operate the scanning tool.



Outside the operating temperature range, a fault message is displayed and the scanning tool automatically switches off. Allow the scanning tool to cool down or warm up, as appropriate, and then switch it on again.

### 5.4 Starting for the first time

1. Insert the battery. → page 13
2. Switch on the scanning tool. → page 13
3. When you start a brand new product for the first time, the **'First startup settings'** screen appears. Select the appropriate settings.
  - ↳ This prompt will not re-appear after you have selected your settings.



You can change **'Date / Time'** and **'Country settings'** at any time in the **'Settings'** menu.

## 6 Operation

### 6.1 Functions of the buttons

	<b>Help</b> button	Context-sensitive display of the operating instructions.
	<b>Home</b> button	Takes you straight back to the main menu.

	<b>Back</b> button	Takes you back to the preceding screen. Additional functions for 'Imagescan'.
	<b>Start / Stop</b> button	Starts and stops the scan. Additional functions for 'Imagescan' and for one-handed operation.
	<b>Mark</b> button	Marks a position in the scan data.
	<b>On / Off</b> button	Switches the scanning tool on or off.

### 6.1.1 One-handed operation

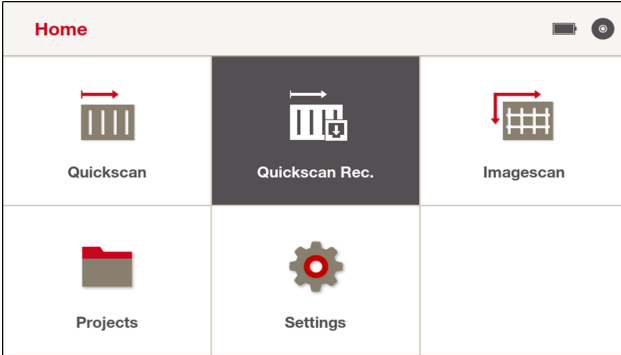

In the main menu and in dialog boxes, you can activate touchscreen buttons with a gray background without having to touch the touchscreen simply by pressing the button. This enables you to operate the PS 300 using only one hand.

## 6.2 Touchscreen

The PS 300 has a touchscreen that responds to different touch inputs:

- Tap to select.
- Fingertip-touch and wipe to browse.
- Fingertip-touch and do not remove to access additional menus.
- Touch the screen with the tips of two fingers close together and move your fingers apart to zoom in. To zoom out, touch the screen with the tips of two fingers spread apart and move your fingers closer together.

### Operation on the basis of an example: Setting the language

1. In the main menu, tap once on 'Settings'.
2. In the Settings menu, tap on 'Country'.
3. Beside 'Language', tap once on the currently selected language. A selection menu opens.
4. Fingertip-touch the area of the selection menu and slide your fingertip up or down to scroll through the menu.
5. Tap the language you want to select. The selection menu closes.
6. Tap at the right edge of the screen to save the setting.  
Whenever you change the language setting a prompt appears, requiring you to accept the disclaimer. The language is set.
7. If, instead of tapping you tap , the changes are discarded and you return to the preceding screen page.

You use the same touch inputs to operate all the other functions via the touchscreen.

### To navigate back:

- To go back one screen page, use the button or, if it is visible, tap the symbol in the top left corner of the touchscreen. The button takes you directly back to the main menu.

### Two or more screen pages:

Small dots at the bottom of the screen indicate that there is more than one screen page in the current menu. To flick from one screen page to another, fingertip-touch the screen and wipe to right or left.

A black dot indicates the screen page that is currently open, gray dots indicate the direction in which you can flick to other screen pages.

### 6.3 Displaying the operating instructions

1. Press the button. The part of the operating instructions appropriate to the current situation appears on the display. You can then browse through the complete operating instructions.
2. Press the button to close the operating instructions.

### 6.4 Status area

Possible symbols in the status area:

	Battery charge state
	Battery state of charge less than 10 %
	Memory
	Free storage space less than 20 %

### 6.5 Information area

The information and data shown in the information area vary, depending on which function you select.

- The symbol indicates that a scan is in progress.
- The symbol for noise appears if electromagnetic interference occurs during a scan.
- **'Position'** shows the position of the scanner and the scan direction.
- **'Marker'** → page 26
- **'File'** → page 36
- **'Filter'** → page 21
- **'Statistics'** → page 21



Wipe to the left in the information area to enlarge the area. Tap on **X** to restore the area to its original size.

### 6.6 Functions

Possible symbols in the Functions section:

	Takes you back to the preceding screen. Discards the last path scanned in the <b>'Imagescan'</b> function.
	Parameters
	Visualization
	Calibration
	Show tips
	For defining the scan direction
	Switches the acoustic signal on/off and changes volume.

## 6.6.1 Calibrate

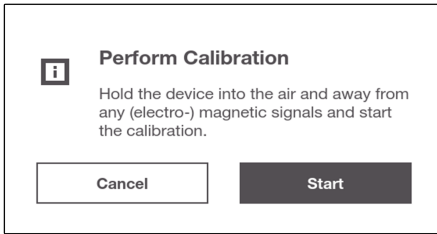

### WARNING

**Incorrect results of the scan.** Inadequate or incorrect calibration can falsify the results of a scan.

- ▶ To calibrate, hold the PS 300 in the air at least 0.5 m (20 in) clear of all objects. Make sure there are no sources of (electro-)magnetic signals in the vicinity.

The PS 300 has to be calibrated before measurement starts.

A symbol appears on the 'Calibrate' button to confirm successful calibration.

If the PS 300 ascertains that recalibration is necessary, a message prompting you to recalibrate the PS 300 appears on the screen. A symbol remains visible on the 'Calibrate' button until calibration is performed.

## 6.7 Switching off the scanning tool

- ▶ Press the button for one second and then release it.
  - ↳ The scanning tool switches itself off.
  - ↳ If a scan is in progress, you are prompted to confirm your intention before the scanning tool will switch itself off.

## 6.8 Removing the battery

1. Press the release buttons on the battery.
2. Pull the battery out of its holder in the device.

## 7 'Quickscan'

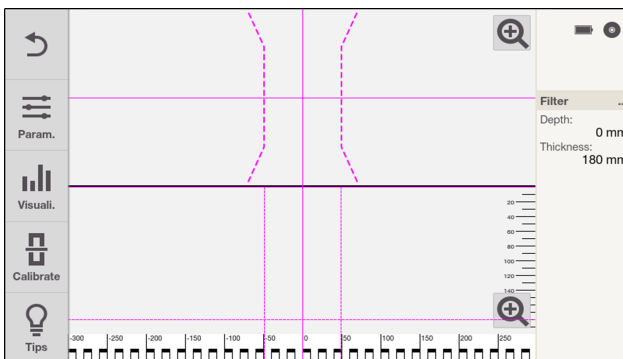

This function enables you to locate reinforcing bars in concrete and other non-ferritic construction materials structures and view them in real time on screen. Reinforcing bars at right angles to the scanning direction are visualized in a top view and cross-sectional view and with the aid of the marking notches, their positions can be marked directly on the scanned surface.

**i** Reinforcing bars parallel to the direction of movement are not detected. So you have to scan the surface horizontally as well as vertically.

Reinforcing bars that are at an angle to the direction of movement might not be shown or might be shown incorrectly, depending on circumstances.

See the section headed "Tips and tricks" for ways of solving certain difficulties and obtaining better results from your scans. → page 43

1. First use **'Country settings'** to select the correct standard for reinforcing bars. → page 39
2. Select **'Quickscan'** from the main menu.
3. For a necessary calibration, in accordance with the instructions that appear on the display hold the scanner in the air and away from all (electro-)magnetic signals.
4. Hold the scanner against the surface of the area to be scanned.
5. Press the button to start scanning. An acoustic signal indicates the start of the scan and a red recording mark appears in the information area.

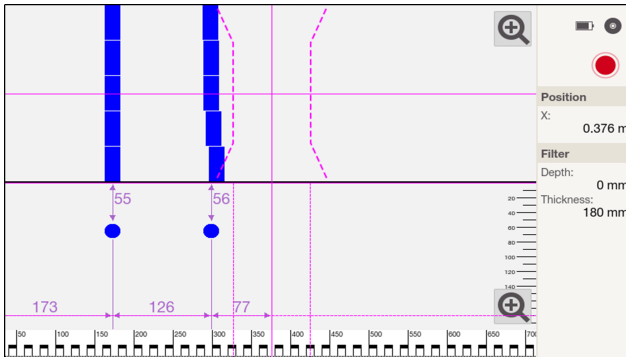

6. Move the scanner to the left or right over the surface to be scanned in order to locate the objects. Read the position of an object using the center line in the display and mark this point on the marking notches between the wheels. Alternatively, use the dashed lines to mark the position of an object along the corresponding edge at the side of the tool. Audible and visual warnings are emitted if the scanner is moved at a speed approaching the maximum permitted scanning speed. If the scanner is moved too quickly the scan will be canceled.
7. Press the to end scanning. A double acoustic signal indicates that the scan has ended.

The symbol for noise appears if electromagnetic interference occurs during a scan. The symbol also appears in analysis. Its purpose is to draw your attention to the fact that the results of the scan might be incorrect.

Try to eliminate possible sources of interference, recalibrate the scanner and verify the results by control measurements and, if necessary, by drilling pilot holes. See also the sections headed "Restrictions on scanning performance → page 43" and "Tips and tricks → page 11".

## 7.1 'Quickscan' analysis

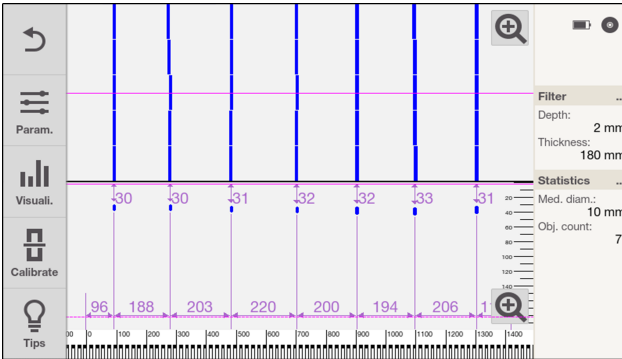

- Wipe to the right or left in the top view or the cross section to move the view.
- To expand the top view or the cross section to full-screen size, tap . To restore to the original size, tap .
- The side edge of the scanner (in the scan direction) is the starting point of the 'Quickscan'.
- The objects appear in top view in the top part of the display and in cross section in the bottom part of the display. The cross section also shows you the spacing and the depth of cover.
- Select the desired scanning path, if necessary. See the section headed "Selecting a scanning path". → page 20
- The information area shows you data on the depth filter → page 21 and the statistics → page 21. See also the corresponding sections.

In the top view, only the objects within the selected depth filter are shown.

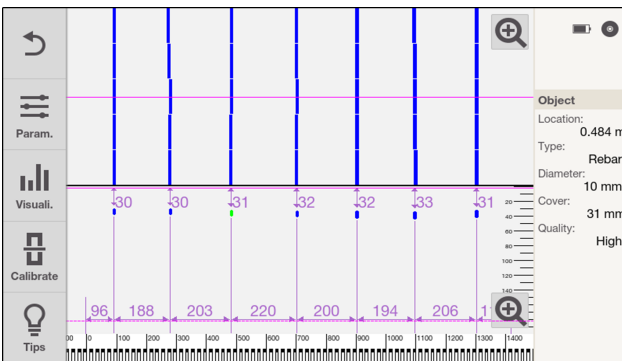

- You can set parameters by tapping the button. → page 19 See the section on '**Parameters**'.
- You can change settings for visualization by tapping the button. → page 20 See the section on '**Visualization**'.

You can make these settings only before or after a scan. It is not possible to make these settings while a scan is in progress.

Tap an object to view the position and additional information in the information area:

- '**Location**': Length of the scan between the starting point of the scan and the middle of the object found.
- '**Type**': '**Rebar**' (reinforcing bar) or '**Mesh**' (welded reinforcement mesh).
- '**Diameter**': Diameter of the reinforcing bar found. A value of 8 mm is always shown for the '**Mesh**' type.
- '**Cover**': Depth of cover over the reinforcing bar found.

- **'Quality'**: The quality of the results of the scan is shown as **'High'** or **'Low'**. If the quality is shown as **'Low'**, eliminate possible sources of interference, recalibrate the scanner and verify the results by control measurements and, if necessary, by drilling pilot holes. See also the sections headed "Restrictions on scanning performance → page 11" and "Tips and tricks → page 43".

### 7.1.1 'Parameters'

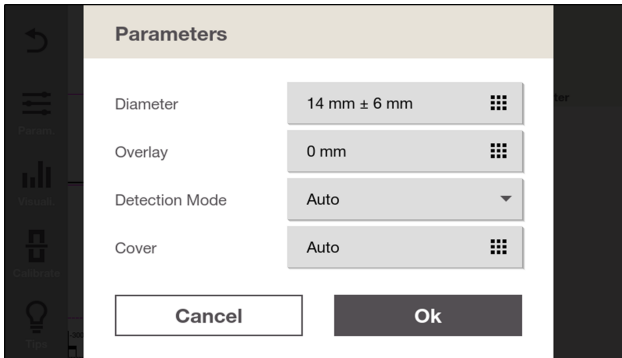

Tap **'Param.'** to change the parameters of the analysis.

- **'Diameter'**: Set the expected diameter of the reinforcing bars. With **'Expert mode'** activated, you can also define the range above and below the selected diameter.  
If a standard is preset (see the **'Country settings'** → page 39 section) a reinforcing bar that is not covered by the standard is rounded up or down, as appropriate. Consequently, even when a diameter has been preset the value actually displayed might be higher or lower.  
When welded reinforcement meshes are detected the system will notify you if the diameter range is outside 6 - 10 mm. The system assumes a reinforcing bar size of 8 mm for welded reinforcement meshes and allows a range of deviation of  $\pm 2$  mm. While the setting applies, values outside this range are shown in red. If you set this value anyway, a message to this effect is issued and the symbol appears beside the values.
- **'Overlay'**: If the surface is uneven you can place an even overlay on the surface to be scanned. Enter the thickness of this overlay here.



You can set the following parameters only if, in "Settings", under Options, the **'Expert mode'** checkbox is activated. → page 40

If the **'Expert mode'** checkbox is deactivated, the following parameters are set automatically.

- **'Detection Mode'**: The choices are welded mesh present or not present, or automatic detection of welded mesh by the system. See the section headed "Tips and tricks". → page 43
- **'Cover'**: Set the expected cover and the range above and below your setting. Alternatively, you can allow automatic detection of cover by the system.

Simultaneous automatic recognition of diameter and cover is not possible. The system issues a message to this effect. The symbol shown here appears at both settings:

To save your settings, exit the menu by tapping the **'Ok'** button. Your settings are not saved if you tap **'Cancel'**.

### 7.1.2 'Visualization'

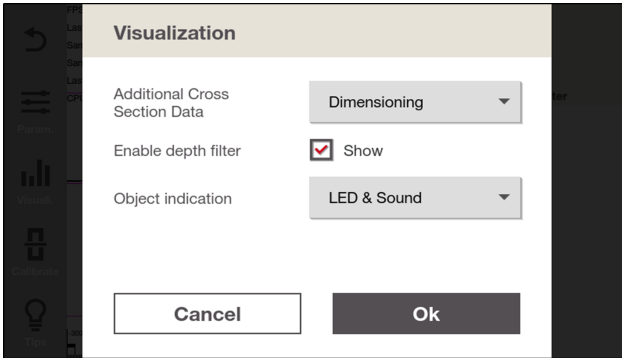

Tap 'Visuali.' to change the visualization of the analysis.

- **'Additional Cross Section Data':**

Select **'Dimensioning'** to view the values for spacing and cover.

Select **'Equivalent Cover'**, to view the equivalent cover. See the section headed "Tips and tricks".  
→ page 43

Select **'None'** to have no values displayed.

Select **'Raw Data'** to have the raw data displayed.

- **'Enable depth filter':** Tick the checkbox to enable the depth filter. See the section headed "Depth filter".  
→ page 21

- **'Object indication':** Select your preferred form of signaling for finding an object: either LED or acoustic signal and LED. Alternatively, you also have the choice of deactivating both visual and acoustic signaling. If signaling is not deactivated the device will always issue a signal to indicate that an object has been found, regardless of the settings for depth and scanning path.

### 7.1.3 Selecting a scanning path

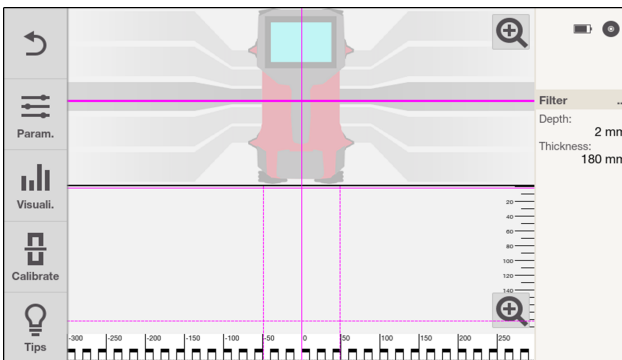

- Place your finger on the continuous line in the top view.
- Select the desired scanning path.

The view in the cross section changes, depending on the path you select.



### 7.1.4 Depth filter

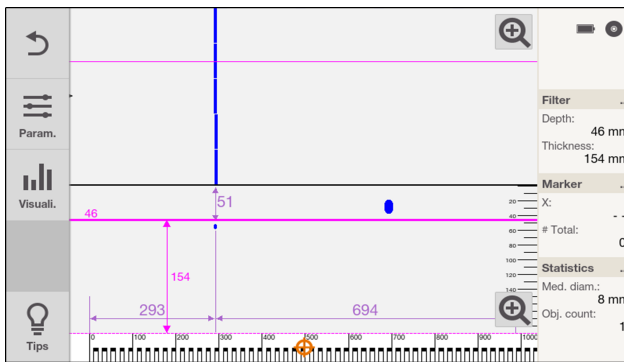

Open **'Visuali.'** and make sure that the **'Enable depth filter'** function is activated.

The scan depth can be limited in the cross-section view. Limiting the scan depth hides all objects outside this limit and excludes them from the statistics.

The continuous line is the top limit, the broken line is the bottom limit. You can move the lines with your fingers.

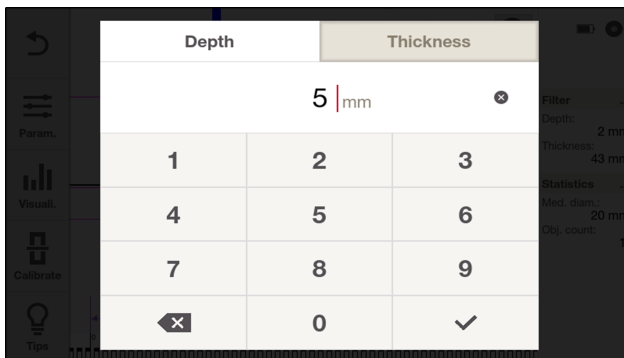

- For an exact setting, long-tap one of the two lines or in the information area, tap **'Filter'**.
- Use **'Depth'** to set the depth and **'Thickness'** to set the thickness of the filtered area.

### 7.1.5 Viewing 'Statistics'.

Statistics			
Number of objects: 5			
	Median	Mean	Standard deviation
Cover	40.0 mm	39.8 mm	0.4 mm
Diameter	12.0 mm	12.0 mm	0.0 mm
Ok			

In the information area, tap **'Statistics'**.

The statistics are shown only for the objects visible in the selected part of the scan.

Double-tap the top view to see the complete scan. Then tap **'Statistics'** to view the statistics for the complete scan.

The statistics are shown only for the selected scanning path, regardless of the part of the scan currently visible on the screen.

## 8 'Quickscan Rec.'

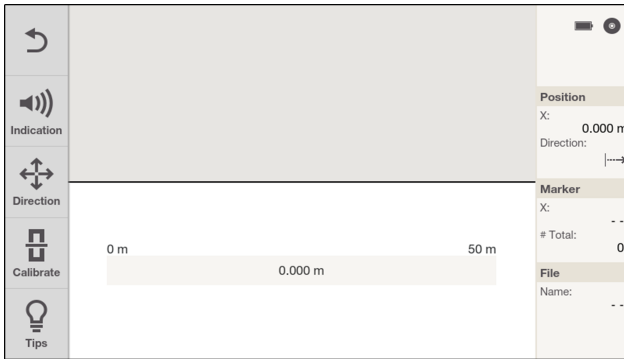

This function enables you to record an extended scanning length in a concrete structure. After the scan ends, reinforcing bars at right angles to the scanning direction can be visualized in a top view and cross-sectional view.

The scans are saved in the active project. The file name appears in the information area; tap the name if you want to edit it.

You can subsequently select **'Projects'** to retrieve the scans for analysis.

Reinforcing bars parallel to the direction of the movement are not detected. So you have to scan the surface horizontally as well as vertically.

Reinforcing bars that are at an angle to the direction of movement might not be shown or might be shown incorrectly, depending on circumstances.

The **'Quickscan Rec.'** is saved in the default project with default settings. **Hilti** recommends first creating a new project. See also the section on **'Projects'**. → page 33

1. Select **'Quickscan Rec.'** from the main menu.
2. For a necessary calibration, in accordance with the instructions that appear on the display hold the scanner in the air and away from all (electro-)magnetic signals.
3. Set the scanning direction, if necessary. Tap on and also follow the instructions in the section headed "Selecting scan direction". → page 23
4. Hold the scanner against the surface of the area to be scanned.

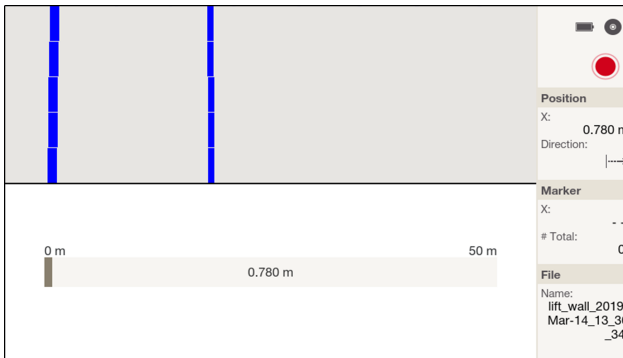

- Press the button to start scanning. An acoustic signal indicates the start of the scan and a red recording mark appears in the information area. You have to scan a length of at least 30 cm (11.81 inches) in order to obtain usable data. The progress bar changes color when the minimum length is reached. The maximum scan length is 50 m (164 ft).
- Move the scanner in the direction you have previously set. Audible and visual warnings are emitted if the scanner is moved at a speed approaching the maximum permitted scanning speed. If the scanner is moved too quickly, the scan is interrupted and the scan is not saved. Do not change the scanning direction. Scanning is automatically canceled and the scan is discarded if you move the scanner more than 15 cm (5.9 inches) in the opposite direction.
- You can set a marker at any time during the scan by pressing the button.  
If you press the button again while the scanner is still at the same position, the marker is deleted.
- Press the to end scanning. A double acoustic signal indicates that the scan has ended. The scan data are saved in the active project.
- Tap the preview area to check the measurement. The 'Param.' and 'Visuali.' buttons enable you to change the calculation and visualization parameters. See also the sections on 'Parameters' and 'Visualization'.

The symbol for noise appears if electromagnetic interference occurs during a scan. The symbol is saved with the scan and also appears in analysis. Its purpose is to draw your attention to the fact that the results of the scan might be incorrect.

Try to eliminate possible sources of interference, recalibrate the scanner and verify the results by control measurements and, if necessary, by drilling pilot holes. See also the sections headed "Restrictions on scanning performance → page 43" and "Tips and tricks → page 11".

## 8.1 Selecting scan direction

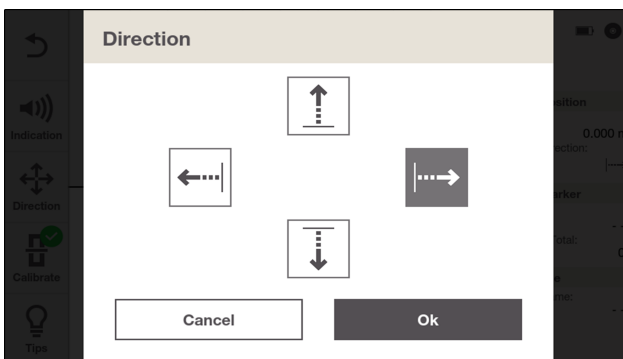

- Tap the 'Direction' button.
- Select the desired scan direction.

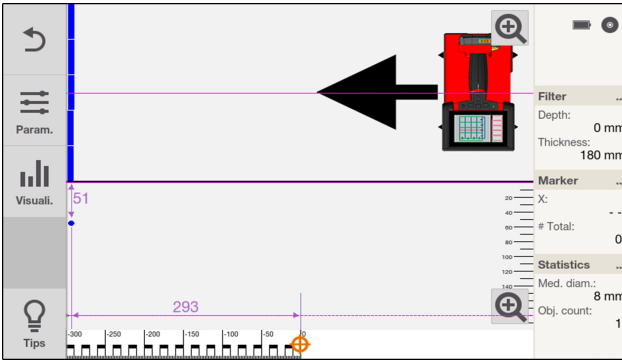

Select the scan direction to suit the actual direction of movement on the surface to be scanned. The direction of movement is saved and can be retrieved in analysis in the PS 300 and in the **Hilti** Detection software. The system automatically detects the orientation in which the PS 300 is held during scanning.

## 8.2 'Quickscan Rec.' analysis

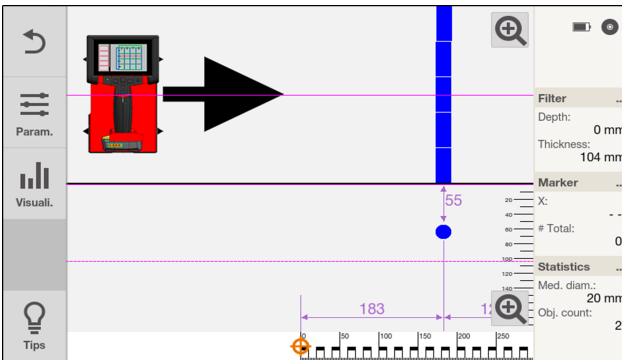

You can have a **'Quickscan Rec.'** displayed and analyzed in different ways with the aid of various visualization and processing parameters. Either tap the preview area after making a **'Quickscan Rec.'** or select a scan saved beforehand in the active project. The arrow indicates the scan direction used in the **'Quickscan Rec.'**. The scanner is shown in the direction in which it is used.

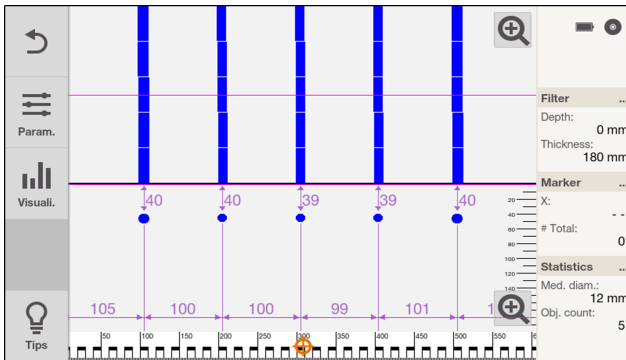

- Wipe to the right or left in the top view or the cross section to move the view.
- To expand the top view or the cross section to full-screen size, tap . To restore to the original size, tap .
- The side edge of the scanner (in the scan direction) is the starting point of the **'Quickscan Rec.'**
- The objects appear in top view in the top part of the display and in cross section in the bottom part of the display. The cross section also shows you the spacing and the depth of cover.
- Select the desired scanning path, if necessary. See the section headed **"Selecting a scanning path"**. → page 28
- The information area shows you data on the depth filter → page 21 and the statistics → page 21. See also the corresponding sections.



In the top view, only the objects within the selected layer thickness range are shown in the image.

- You can set parameters by tapping the **'Param.'** button. See also the section on **'Parameters'**. → page 27
- You can change settings for visualization by tapping the **'Visuali.'** button. See also the section on **'Visualization'**. → page 27



You can make these settings only before or after a scan. It is not possible to make these settings while a scan is in progress.

Tap an object to view the position and additional information in the information area:

- **'Location'**: Length of the scan between the starting point of the scan and the middle of the object found.
- **'Type'**: **'Rebar'** (reinforcing bar) or **'Mesh'** (welded reinforcement mesh).
- **'Diameter'**: Diameter of the reinforcing bar found. A value of 8 mm is always shown for the **'Mesh'** type.
- **'Cover'**: Depth of cover over the reinforcing bar found.
- **'Quality'**: The quality of the results of the scan is shown as **'High'** or **'Low'**. If the quality is shown as **'Low'**, eliminate possible sources of interference, recalibrate the scanner and verify the results by control measurements and, if necessary, by drilling pilot holes. See also the sections headed "Restrictions on scanning performance → page 11" and "Tips and tricks → page 43".

## 8.2.1 Setting, editing and deleting 'Markers'

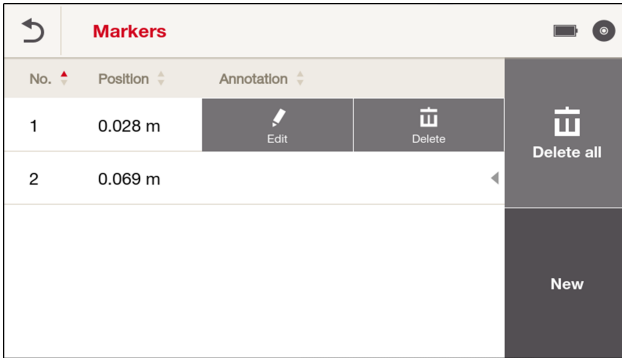

Markers can be set during the scan and in the course of analysis.

1. In the information area, tap **'Markers'**.
2. To add a marker, tap **'New'**. Then define the position and, if necessary, add a comment.
3. To edit an existing marker, long-tap on the marker in question or wipe it to the left.
  - > A selection menu opens.
4. To edit the marker, tap **'Edit'**.
5. To delete the marker, tap **'Delete'** and answer the prompt requesting you to confirm your intention.

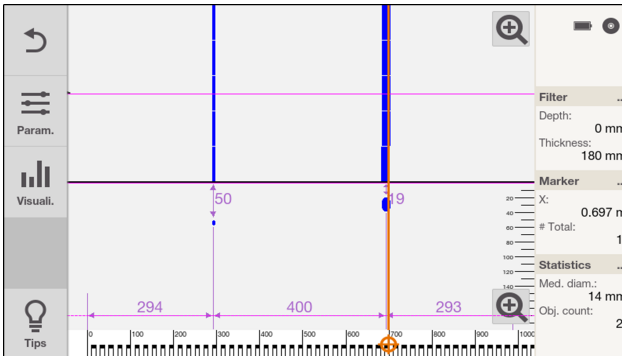

Move the cursor along the ruler at the bottom of the screen.

- When the position of the cursor coincides with an existing marker, the marker's position appears in the information area.
- If you press the button when the cursor is in an unoccupied position, and additional marker is inserted.
- If you press the button when the cursor coincides with an existing marker, the marker is deleted. You will be prompted to confirm your intention.

## 8.2.2 'Parameters'

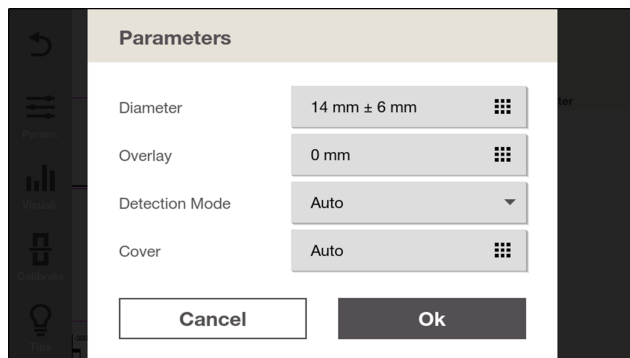

Tap 'Param.' to change the parameters of the analysis.

- **'Diameter'**: Set the expected diameter of the reinforcing bars. With **'Expert mode'** activated, you can also define the range above and below the selected diameter.  
If a standard is preset (see the **'Country settings'** → page 39 section) a reinforcing bar that is not covered by the standard is rounded up or down, as appropriate. Consequently, even when a diameter has been preset the value actually displayed might be higher or lower.  
When welded reinforcement meshes are detected the system will notify you if the diameter range is outside 6 - 10 mm. The system assumes a reinforcing bar size of 8 mm for welded reinforcement meshes and allows a range of deviation of  $\pm 2$  mm. While the setting applies, values outside this range are shown in red. If you set this value anyway, a message to this effect is issued and the symbol appears beside the values.
- **'Overlay'**: If the surface is uneven you can place an even overlay on the surface to be scanned. Enter the thickness of this overlay here.



You can set the following parameters only if, in "Settings", under Options, the **'Expert mode'** checkbox is activated. → page 40

If the **'Expert mode'** checkbox is deactivated, the following parameters are set automatically.

- **'Detection Mode'**: The choices are welded mesh present or not present, or automatic detection of welded mesh by the system. See the section headed "Tips and tricks". → page 43
- **'Cover'**: Set the expected cover and the range above and below your setting. Alternatively, you can allow automatic detection of cover by the system.

Simultaneous automatic recognition of diameter and cover is not possible. The system issues a message to this effect. The symbol shown here appears at both settings:

To save your settings, exit the menu by tapping the **'OK'** button. Your settings are not saved if you tap **'Cancel'**.

## 8.2.3 'Visualization'

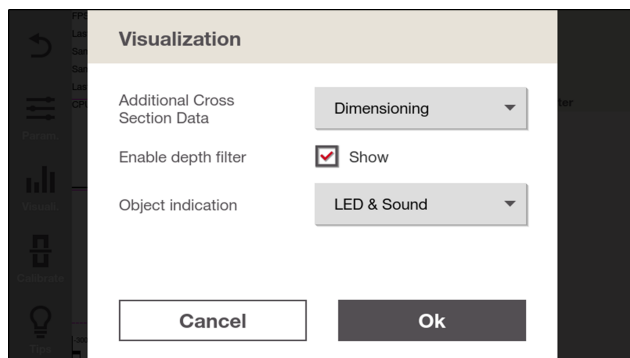

Tap 'Visuali.' to change the visualization of the analysis.

- **'Additional Cross Section Data':**  
 Select **'Dimensioning'** to view the values for spacing and cover.  
 Select **'Equivalent Cover'**, to view the equivalent cover. See the section headed "Tips and tricks".  
 → page 43  
 Select **'None'** to have no values displayed.  
 Select **'Raw Data'** to have the raw data displayed.
- **'Enable depth filter':** Tick the checkbox to enable the depth filter. See the section headed "Depth filter".  
 → page 28
- **'Object indication':** Select your preferred form of signaling for finding an object: either LED or acoustic signal and LED. Alternatively, you also have the choice of deactivating both visual and acoustic signaling. If signaling is not deactivated the device will always issue a signal to indicate that an object has been found, regardless of the settings for depth and scanning path.

### 8.2.4 Selecting a scanning path

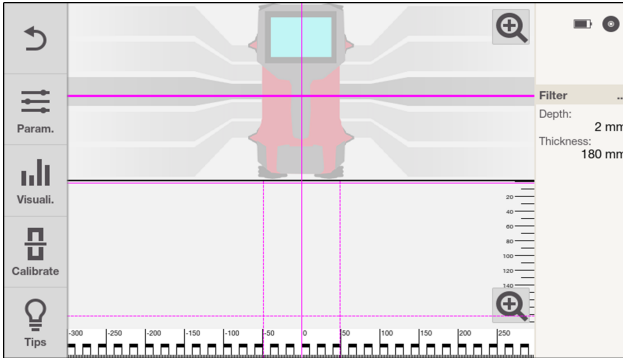

- Place your finger on the continuous line in the top view.
- Select the desired scanning path.

The view in the cross section changes, depending on the path you select.

### 8.2.5 Depth filter

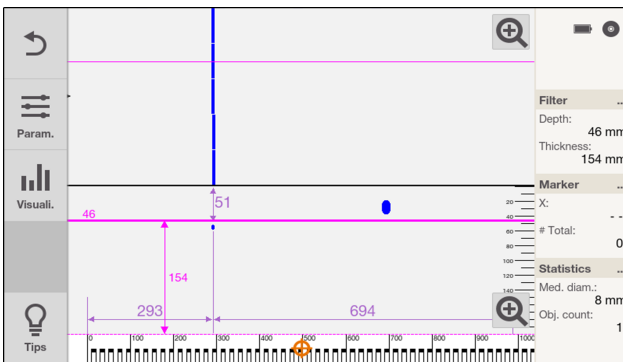

Open **'Visuali.'** and make sure that the **'Enable depth filter'** function is activated.

The scan depth can be limited in the cross-section view. Limiting the scan depth hides all objects outside this limit and excludes them from the statistics.

The continuous line is the top limit, the broken line is the bottom limit. You can move the lines with your fingers.



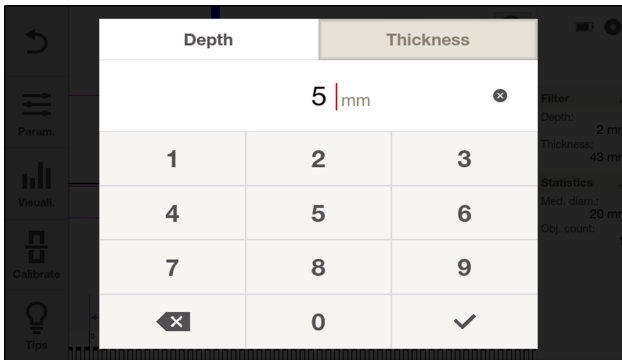

- For an exact setting, long-tap one of the two lines or in the information area, tap **'Filter'**.
- Use **'Depth'** to set the depth and **'Thickness'** to set the thickness of the filtered area.

### 8.2.6 Viewing 'Statistics'.

Statistics			
Number of objects: 5			
	Median	Mean	Standard deviation
Cover	40.0 mm	39.8 mm	0.4 mm
Diameter	12.0 mm	12.0 mm	0.0 mm
Ok			

In the information area, tap **'Statistics'**.

The statistics are shown only for the objects visible in the selected part of the scan.

Double-tap the top view to see the complete scan. Then tap **'Statistics'** to view the statistics for the complete scan.

The statistics are shown only for the selected scanning path, regardless of the part of the scan currently visible on the screen.

## 9 'Imagescan'

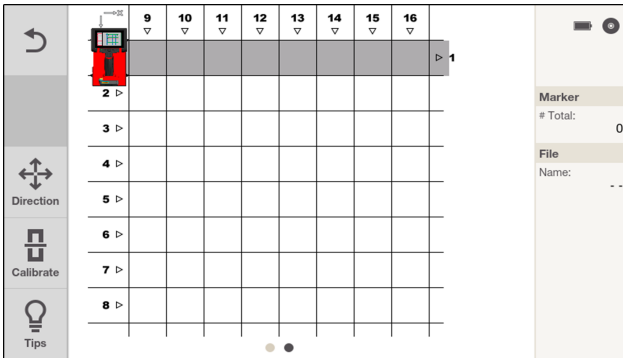

Use this function to view a large-area image of reinforcing bars in concrete structures. The reinforcing bars are visualized in a top view.

The scans are saved in the active project. The file name appears in the information area; tap the name if you want to edit it.

1. Perform a **'Quickscan'** to evaluate the orientation of the objects. → page 16
2. Place the reference grid on the surface to be scanned at right angles to the direction in which the objects are oriented and secure it with the adhesive tape.  
Brush dusty surfaces clean beforehand.



The distances indicated by the scanner display and by the reference grid correspond only when the reference grid is stretched taut and securely affixed to the surface.

3. Select **'Imagescan'** from the main menu.
4. Wipe to the right or left to select the reference grid size, as necessary. Then tap the **'Direction'** button to select the starting point.



Available grid sizes: 60 x 60 cm (22 x 22 in) and 120 x 120 cm (46 x 46 in)

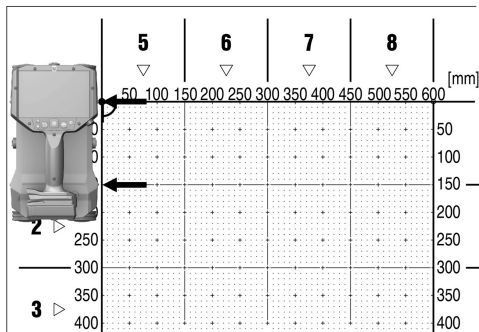

5. Hold the scanner against the surface of the area to be examined, at the starting point and in line with the grid.  
The reference is the **side edge** of the PS 300, which has to be set on the vertical grid datum. The marking projections that project sideways must be in exact alignment with the horizontal lines.

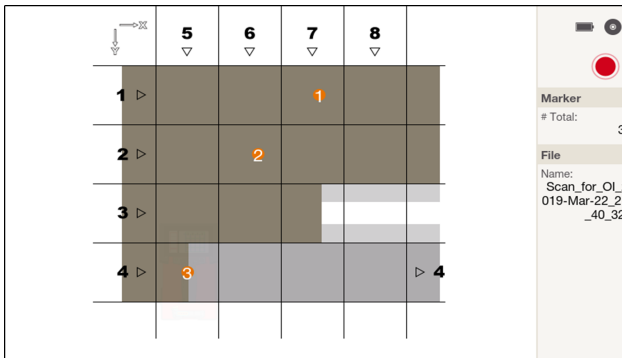

6. Press the button to start scanning. An acoustic signal indicates the start of the scan and a red recording mark appears in the information area. You have to scan a length of at least 30 cm (11.8 inches) in order to obtain usable data. The progress bar changes color when the minimum length is reached.

A double acoustic signal indicates the end of the path to be scanned. The scan ends automatically at the end of each path. You can end a path prematurely by pressing the button. Unscanned areas are visually highlighted.

7. Move the scanner over the area to be examined along the paths indicated by the reference grid. Scan all paths and adhere to the correct sequence. Scanning progress is indicated by a bar in the display. If the scanner is moved at a speed approaching the permissible limit, an acoustic and visual warning is issued. If the scanner is moved too quickly, the scan is interrupted and the path has to be rescanned.

8. You can set a marker at any time during the scan by pressing the button.

The markers are cumbered consecutively and are always centered per line. After the last path has been scanned, the position of each marker can be changed in the preview.

If you press the button again while the scanner is still at the same position, the marker is deleted.

9. Press the button twice in quick succession to skip a path.

10. Press the button to discard the last path scanned. You can then scan the path again.

11. Repeatedly press the button to discard the complete scan. This will discard each path in succession, finally returning you to the start screen of the 'Imagescan'. Alternatively, long-press the button.

12. The result of the scan is displayed after the last path has been scanned. The scan data are saved in the active project.

## 9.1 'Imagescan' Preview

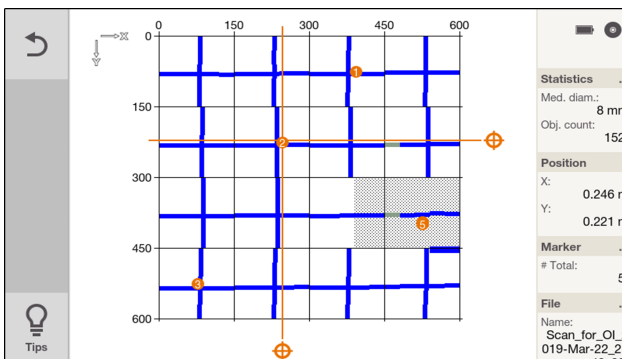

When the last scanning path has been scanned, the Imagescan Preview opens automatically.

The Imagescan is shown in top view only.

Visualization is always with the following default settings:

- **'Diameter':** 14 ± 6 mm

- **'Overlay': 0**
- **'Detection Mode': 'Auto'**
- **'Cover': 'Auto'**

There are two cursors visible in the display. They enable you to navigate to any position on the X and Y axes.

The information area contains the following information:

- The **'Statistics'** of the scan.  
Tap to view the complete statistics.
- The exact **'Position'** on the X and Y axes.  
Tap to open a menu where you can enter the exact position manually.
- The **'Marker'**.  
See the **'Marker'** section below.
- The file name of the scan.

## 9.2 Setting, editing and deleting 'Markers'

No.	x-Position	y-Position	Annotation
1	0.311 m	0.075 m	
2	0.157 m	0.225 m	
3	0.024 m	0.375 m	

1. In the information area, tap **'Markers'**.
2. To add a marker, tap **'New'**. Then define the position and, if necessary, add a comment.
3. To edit an existing marker, long-tap on the marker in question or wipe it to the left.  
» A selection menu opens.
4. To edit the marker, tap **'Edit'**.
5. To delete the marker, tap **'Delete'** and answer the prompt requesting you to confirm your intention.

You can also add a marker by moving both cursors to the appropriate position and then pressing the button. If there is a marker at this position, you can delete it by pressing the button. You will be prompted to confirm your intention.

## 10 'Projects'

Name	# Total	Date	
lift wall	2	2019-03-14	Delete all
default	6		
lb	2	2019-03-14	Transfer
			New

This function can be used to manage projects and to display and evaluate recorded scans.

1. Select **'Projects'** from the main menu.
2. Select the desired project. The active project always appears at the top of the list, with a marker in the top left corner. The data from the next scan will be saved under this active project.

### 10.1 Creating a new project

**Create new project**

Project name:

Location:

Buttons: Cancel, Save

Keyboard overlay: q w e r t y u i o p, a s d f g h j k l, z x c v b n m, Cancel, 123, ←, →, Save

Tap the **'New'** button.

1. Enter a name for the project.
2. Enter data in all the other fields as necessary.
3. Tap ✓ to end your entry.



If the name already exists, you will be notified accordingly. In this case, enter a different name.

## 10.2 Retrieving and editing project information

You can view and also edit the information about a project.

1. Long-tap the project you want, or wipe to the left on the project.
  - » A selection menu opens.
2. Tap **'Edit'**.
  - » A new window opens.
3. Tap a field to edit its content. Press **'Save'** to end your entry.
4. Press the ✓ button to exit the screen and save your entries.

## 10.3 Activating project

Name	# Total	Date
Scan for OI	5	2019-03-14
asd	3	2019-03-15
default		

Step through the procedure below to activate a project:

1. Long-tap the project you want, or wipe to the left on the project.
  - » A selection menu opens.
2. Tap **'Set active'**.
  - » A marker for the project is set in the top left corner and the project appears at the top of the list of projects.



Scans from **'Quickscan Rec.'** and **'Imagescan'** are always saved in the active project.

## 10.4 Deleting projects

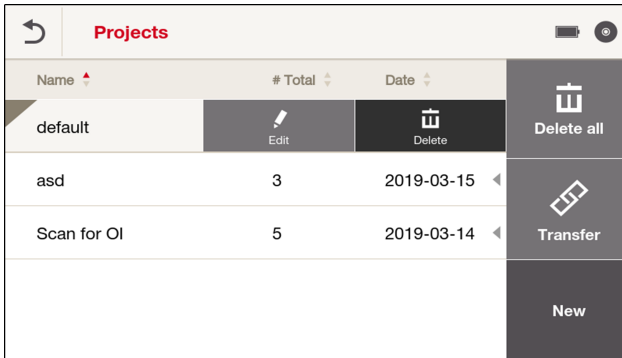

You can delete a single project or all projects.

### To delete a single project:

1. Long-tap the project you want, or wipe to the left on the project.  
» A selection menu opens.
2. Tap **'Delete'**.
3. Answer the prompt requesting you to confirm your intention.

### To delete all projects:

4. Tap **'Delete all'**.
5. Answer the prompt requesting you to confirm your intention.

## 10.5 Data transfer



Place the PS 300 on a level, vibration-free surface where it can remain for as long as the data link has to be maintained.

### Data transfer by data cable

Connect the PS 300 by the PSA 54 data cable to the PSA 200 or a PC.

Follow the instructions issued by the PSA 200 or the **Hilti** Detection software. Also comply with the operating instructions of the PSA 200 or the user guide for the software.

### Data transfer by WiFi (only PS 300-W)

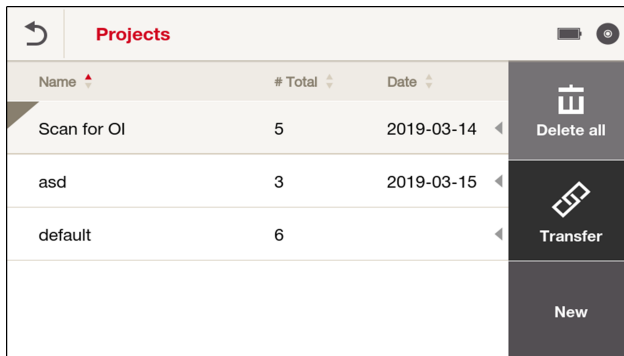

1. Tap
2. Start the import on the PSA 200. Also follow the operating instructions of the PSA 200.

## 10.6 Managing scans

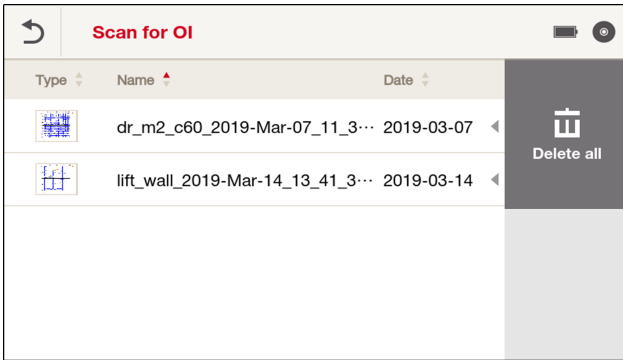

A project contains Imagescans and Quickscan Recordings in a list.

The sort order of the scans depends on the sort column and the sort direction you selected. Each scan that has been opened at least once is represented by a preview icon. A scan that has not yet been opened is represented by an icon indicating that it is an Imagescan or a Quickscan recording.

Tap a scan to open it for analysis.

## 10.7 Editing the name of a scan

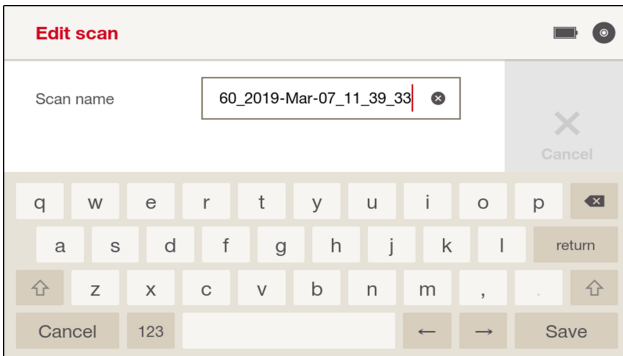

1. Long-tap the project you want, or wipe to the left on the project.
  - » A selection menu opens.
2. Tap **'Edit'**.
  - » A new window opens.
3. Tap the field to edit its content. Press **'Save'** to end your entry.
4. Press the ✓ button to exit the screen and save your entries.



## 10.8 Move scan to another project

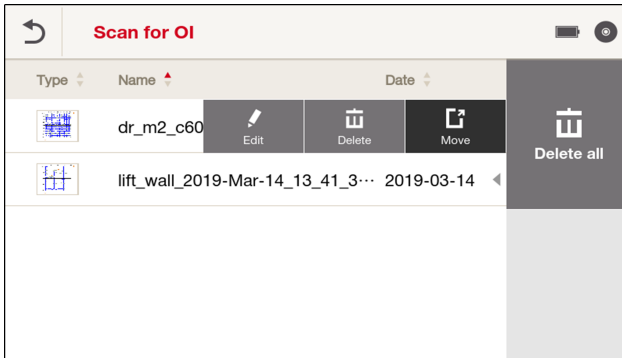

1. Long-tap the scan you want, or wipe to the left on the scan.
  - » A selection menu opens.
2. Tap **'Move'**
  - » You are taken to an overview of all the available projects.
3. Tap the project to which you want to move the scan and answer the prompt requesting you to confirm your intention.
  - » The scan is filed in the selected project.

## 10.9 Deleting scans

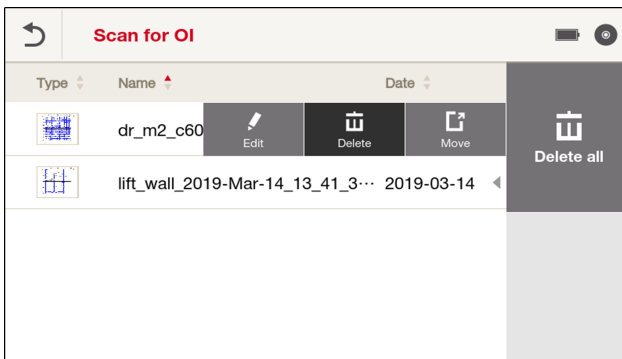

You can delete a single scan or all scans.

### To delete a single scan:

1. Long-tap the scan you want, or wipe to the left on the scan.
  - » A selection menu opens.
2. Tap **'Delete'**.
3. Answer the prompt requesting you to confirm your intention.

### To delete all scans:

4. Tap **'Delete all'**.
5. Answer the prompt requesting you to confirm your intention.

## 11 Settings

### 11.1 The 'Settings' menu

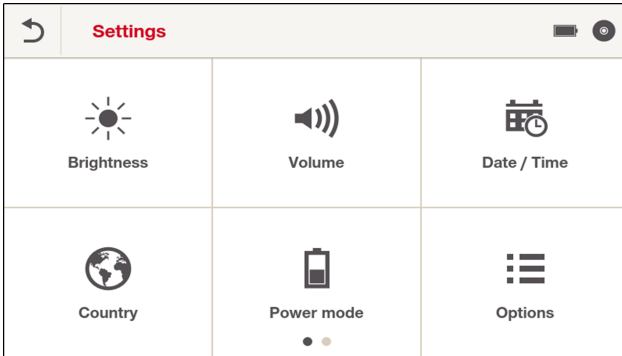

Tap one of the buttons to open the menu for the corresponding setting.

#### 11.1.1 'Brightness'

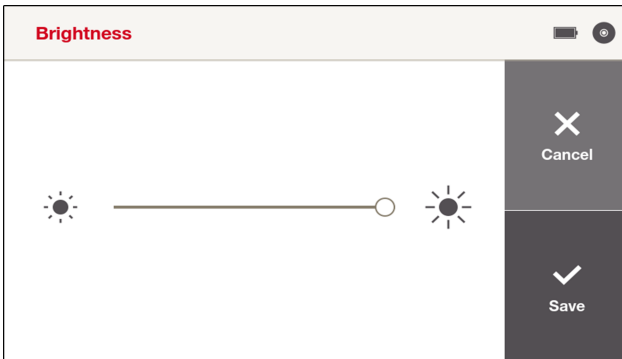

Move the slide control right or left to change the brightness of the screen.  
Use the ✓ button to save a setting. Tap the ✕ button to discard a change.

#### 11.1.2 'Volume'

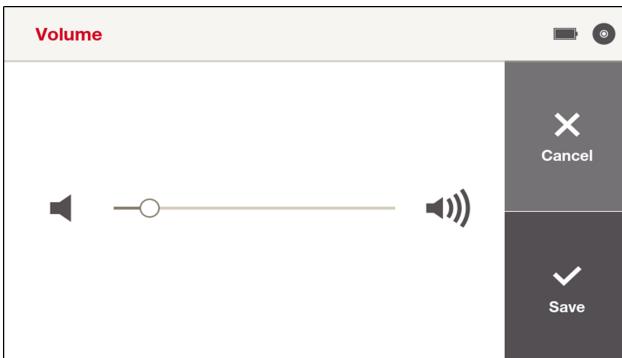

Move the slide control right or left to change the volume.  
Use the ✓ button to save a setting. Tap the ✕ button to discard a change.

### 11.1.3 'Date / Time'

The following settings can be adjusted:

- **'Date'**: Date
- **'Date Format'**: Date format
- **'Time'**: Time
- **'Time Format'**: Time format (12 / 24 hours)

Use the ✓ button to save a setting. Tap the ✕ button to discard a change.

### 11.1.4 'Country settings'

The following settings can be adjusted:

- **'Language'**: Language
- **'Country'**: Country
- **'Unit system'**: Units system (not available in Japan)
- **'Standard'**: Select the desired reinforcing-bar standard. Select **'None'** if you want to view a very accurate reading. When you select a standard, the software rounds off the thickness of the scanned reinforcing bar to the nearest value given in the standard.

Use the ✓ button to save a setting. Tap the ✕ button to discard a change.

---

 If you change **'Country'**, in many instances the reinforcing-bar standard is also automatically adapted to suit. You can select the **'Standard'** at any time, irrespective of the country settings.

---

### 11.1.5 'Power mode'

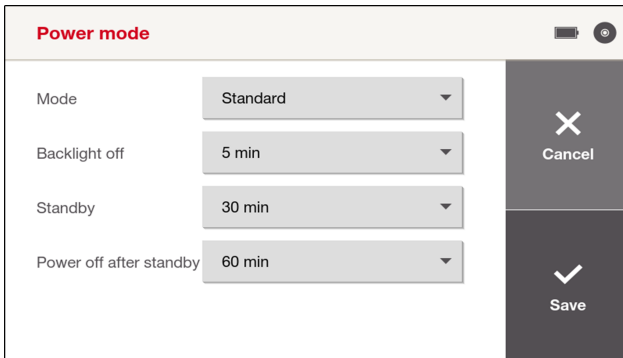

The following settings can be adjusted:

- **'Mode'**: Select preset.
- **'Backlight off'**: Switch off backlight after the preset length of time has elapsed.
- **'Standby'**: Change to standby mode after the preset length of time has elapsed.
- **'Power off after standby'**: Switch off scanning tool after the preset length of time has elapsed.

Use the ✓ button to save a setting. Tap the ✕ button to discard a change.

### 11.1.6 'Options'

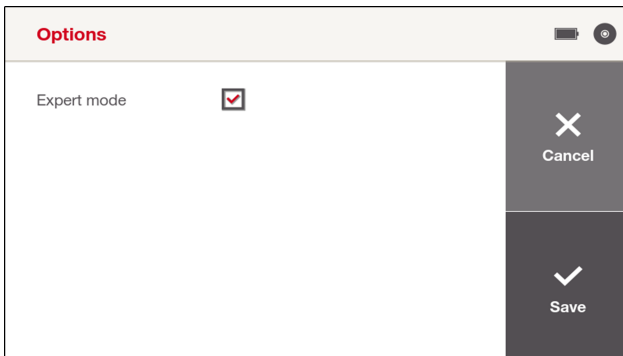

Tick the checkbox to activate or clear the checkbox to deactivate the corresponding option.

- **'Expert mode'**: Enables extended settings for professional users.

Use the ✓ button to save a setting. Tap the ✕ button to discard a change.

### 11.1.7 'Info'

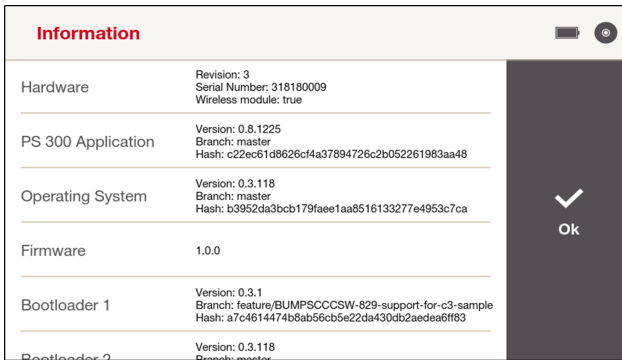

You can view the software status here and also call up further information.

Tap the ✓ button or press the ⏪ button to exit.

### 11.1.8 'Factory Reset'

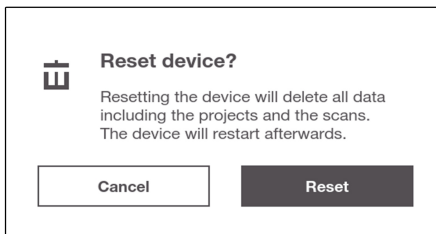

You can reset all the parameters of the PS 300 to their factory default settings.

Tap the ✓ button to confirm the reset. Tap the ✕ button to cancel the operation.

### 11.1.9 'Update'

---

Place the PS 300 on a level, vibration-free surface where it can remain for as long as the data link has to be maintained.

---

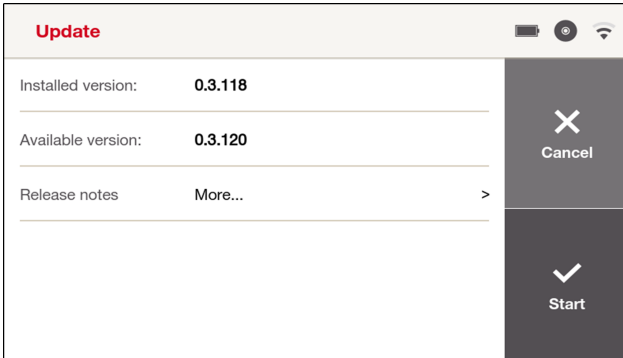

### Connection by data cable

1. Connect the PS 300 to a PC by means of the data cable.
2. Follow the instructions issued by the **Hilti** Detection software.  
The update is transferred to the PS 300.
3. Afterwards, disconnect the data cable from the PC and the PS 300.
4. Tap on the ✓ button to start the installation procedure. If you tap on the X button, the update is rejected.

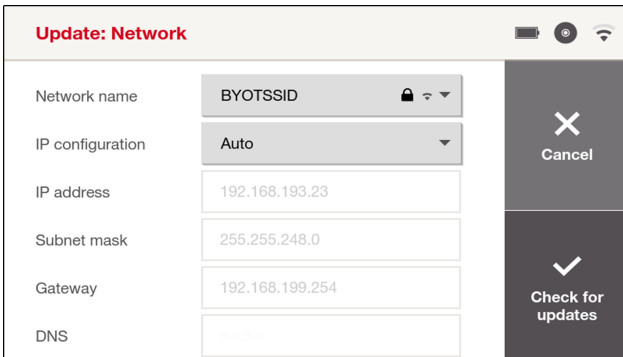

### Connection by WiFi (only PS 300-W)

1. Tap the 'Update' button.
2. Select the wireless network you want to use and, if it is a protected network, enter your user name and the password. Select the other parameters manually, as necessary.
3. Tap on ✓ to establish the connection.
4. The current version appears on the screen. A newer version, if available, appears as well.  
Tap on ✓ to start the download.  
When the download completes, the installation procedure starts automatically.
5. The update will be rejected if you tap on X or 'Cancel' during one of the steps.



The software can be updated only if the battery is sufficiently charged. If battery charge level is too low, a message to this effect appears on the display. Under these circumstances, first recharge the battery or insert a sufficiently charged battery.

### 11.1.10 Travel-sensor test

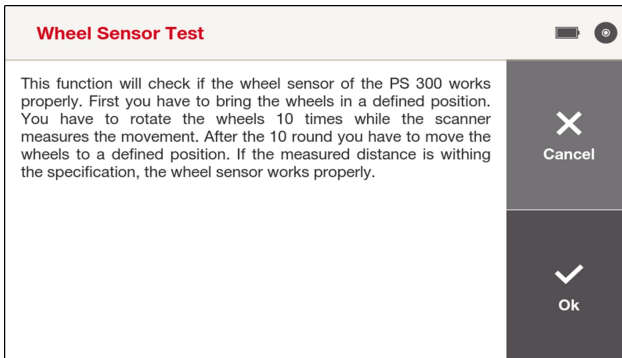

This function enables to you test the travel sensor in your PS 300 to ascertain whether it is functioning correctly.

Start the test by tapping the ✓ button. Tap the ✕ button to cancel the operation.

Then follow the instructions as they appear on the screen.

Once the test concludes, you receive a message either confirming correct operation of the travel sensor or indicating a fault. If the system reports that the travel sensor is not functioning correctly, stop using the PS 300 and consult **Hilti** Service.

## 12 Optional accessories

### 12.1 Using the PS 300 with the PSA 71 telescopic extension (accessory)

#### CAUTION

**Caution** Risk of injury by falling scanning tool!

- ▶ When working with the PSA 71 telescopic extension, always wear a hard hat!
- ▶ Check that the wrist strap of the PS 300 is looped round the bow handle of the PSA 71!
- ▶ Make sure that the securing screws of the PSA 71 are firmly tightened in the PS 300!
- ▶ Always hold the PSA 71 firmly with both hands and keep a firm footing at all times!

#### CAUTION

**Caution** Risk of injury by trapping fingers!

- ▶ When installing and using the PSA 71, do not insert your fingers between the bow handle and the PS 300!

When you have to work with the PS 300 in places that are hard to reach, such as ceilings for example, you can use the PSA 71 telescopic extension to extend your reach.

1. Loop the wrist strap of the PS 300 round the bow handle of the PSA 71.
2. Connect the bow handle of the PSA 71 to the mounts on the PS 300 and tighten the screws.
3. Pull the light-colored, non-conductive section of the PSA 71 out to its full length.
4. First calibrate the PS 300 and then start scanning.

## 13 Tips and tricks

This section is a collection of interactions and useful notes on using the device. It tells users how to deal with certain situations and how best to set the parameters of the PS 300.

### 13.1 General

- Calibrate the sensors at regular intervals, at the latest when the corresponding prompt appears on the display. → page 16
- With presets for diameter and cover (☰ → **'Diameter'** and, respectively, ☷ → **'Cover'**), the smaller the range (+/-) the better your results will be.
- Use the diameter range setting only for the range +/- 8 mm (0.31 in). If the range is more than +/- 8 mm (0.31 in) for diameter or for cover, a local mean is calculated for diameter or cover, as applicable, so

that the system can return more uniform results. Large changes in diameter or changes in cover / discontinuities are not visible. This can lead to considerable variations in the figures calculated for cover and diameter.

- The scanner's estimate of diameter or cover is more reliable given a homogeneous diameter/cover distribution.

In these circumstances, a diameter range or a cover range of more than +/- 8 mm (0.31 in) is advantageous.

- A deviation from a vertical line across all five sensors can be indicative of a hidden metal part beside the reinforcing bar being scanned (e.g. nail, screw, metal plate, indication of presence of other reinforcing bars, end of a reinforcing bar, ...).
- Do not have more than one scanner in operation at a time, because mutual electromagnetic interference between devices can affect the results of the scans.
- The sensors pick up only transverse reinforcing bars (i.e. reinforcing bars that are normal to the scanning direction). Consequently, the transverse reinforcing bars should be in the first layer in order for the device to return a correct estimate of the cover and the best-case estimates. If the orientation of the reinforcement is not known, try scans in both scanning directions and use the results of the transverse reinforcement in the first layer.

Scans over insulated longitudinal reinforcing bars can return incorrect figures caused by signal modulations produced by rough surfaces. These scans often produce figures for cover and diameter that differ widely from those for the rest of the reinforcement.

- The best results are obtained for **'Quickscan'** or **'Quickscan Rec.'** when at least three objects have been scanned.
- Bear in mind that the results of objects at edges are not as reliable, because the algorithm does not know the neighbors on the other side of the objects.
- An uneven surface causes signal noise and falsifies the results of measurement. Clean or smooth the surface if possible. Alternatively, place a thin, smooth, non-metallic overlay on the surface to be scanned. Enter the thickness of the overlay in **'Parameters'**. → page 27  
An overlay of this nature can also be used if the object to be scanned is too narrow, or if the reinforcing bars are close to an edge. The overlay enables you to scan past the edge of the object.
- If the warning for electromagnetic interference (noise) appears , the sensitivity of the scan can be reduced. Try reducing the speed of the scan.
- If you have a large number of scans to be processed, managed and analyzed in detail, when in the field also use the PSA 200 tablet or when in the office use the **Hilti** detection software on your PC.

### 13.2 Deep objects

When reinforcement structures have deep objects (> 8 cm (3.15 in)), a pre-scan calibration can significantly improve the results.

Zoom in on the cross section to increase the scale to 220 mm (8.66 in). This makes it easier to locate very deep objects.

### 13.3 Non-welded reinforcement structures

For reinforcement structures that do not consist of welded grids, you can obtain the best results for diameter and cover by using a preset for one of the two values.

To determine cover when diameter is known:

1. Before starting the scan, navigate to  → **'Diameter'** and set the diameter as accurately as possible.
2. Extend the range by +/- 2 mm (0.08 in). Especially if the exact diameter is not known.  
Bear in mind, however, that the accuracy of the figure calculated for cover decreases when the range (+/-) for diameter is large.
3. Perform the scan.
4. The system will determine the depth of cover.

To estimate diameter when cover is known:

1. Before starting the scan, navigate to  → **'Cover'** and set the cover as accurately as possible.
2. Extend the range if the exact cover is not known. Bear in mind, however, that the accuracy of the diameter estimate decreases when the range (+/-) for cover is large.
3. Perform the scan.
4. The system will estimate the diameter.



### 13.4 Reinforcement structures with significantly different diameters

For reinforcement structures with significant differences in the diameters of the reinforcing bars, you will obtain the best results by adopting the following procedure:

1. Determine the cover as accurately as possible (e.g. by measuring cover or by exploratory drilling).
2. Navigate to → '**Cover**' and enter this value as the depth of cover and also enter a range.
3. Perform the scan.

As an alternative to using a preset for cover, you can navigate to → '**Diameter**', enter a diameter and set a large range.

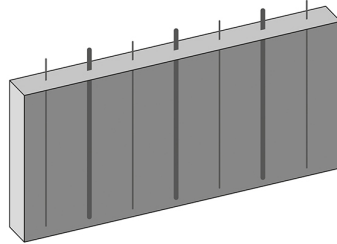

Remember not to set the diameter range to more than +/- 8 mm (see the section headed "General").

Another alternative is to proceed as follows:

1. Set a plausible diameter and as small a diameter range as possible.
2. Perform the scan and then take the median cover from the statistics of the scanning path with the least interference.
3. Select the median cover with as small a cover range as possible as the preset. Select '**Auto**' for the diameter.
4. Calculate again or perform a new scan.

If the diameter is completely unknown, proceed as follows:

1. Set an average diameter with a large diameter range (e.g. 16 mm +/- 20 mm). Bear in mind that diameter discontinuities will be smoothed (see the section headed "General").
2. Perform the scan and then take the median cover from the statistics of the scanning path with the least interference.
3. Select the median cover with as small a cover range as possible as the preset. Select '**Auto**' for the diameter.
4. Calculate again or perform a new scan.

### 13.5 Reinforcement structures with single and double reinforcement

For reinforcement structures with single and double reinforcement, you will obtain the best results by adopting the following procedure:

1. On the basis of the expected diameter of one reinforcing bar, calculate the expected values for single and double reinforcement.
2. Navigate to → '**Diameter**' and set the diameter and the range to cover detection of both single and double reinforcing bars. As an example, assume the expected diameter of one reinforcing bar to be 10 mm (0.4 in); so the diameter can be set for example to 14 mm (0.55 in) and the range to +/- 6 mm (0.24 in). If a diameter of 20 mm is expected, you can set the diameter to 28 mm and the diameter range to +/- 8 mm. Note: A large error is possible if the diameter and the double diameter are far outside the diameter range you set. Remember not to set the diameter

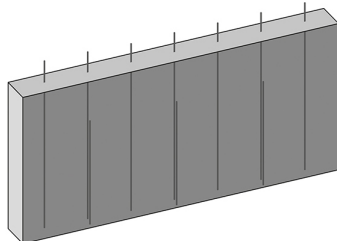

range to more than  $\pm 8$  mm (see the section headed "General").

3. Perform a scan with this preset diameter to obtain an estimate of the cover (e.g. mean value).
4. Navigate to → **'Cover'** and enter this value as the setting for cover.
5. Calculate again or perform a new scan.

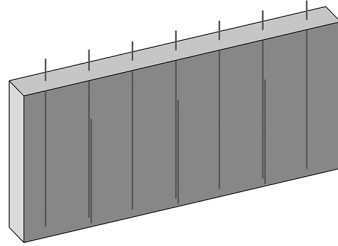

### 13.6 Reinforcement structures with significant differences in cover or upright reinforcing bars

For reinforcement structures with significant differences in cover or upright reinforcing bars, you will obtain the best results by adopting the following procedure:

1. Before starting the scan, navigate to → **'Diameter'** and set the diameter as accurately as possible.
2. Extend the range if the exact diameter is not known.  
The smaller the range ( $\pm$ ), the better the results. However, this applies only in the case of structures with homogeneous diameter distribution.
3. Calculate again or perform a new scan.

As an alternative to using a preset for diameter, you can navigate to → **'Cover'**, enter a cover and also set a large range.

### 13.7 Welded reinforcement meshes

If welded reinforcement meshes are expected, navigate to → **'Detection Mode'** and set the parameter accordingly:

- **'Mesh'**: For forced detection of welded reinforcement meshes when their presence is certain or very probable.
  - **'Auto'**: For automatic detection of welded reinforcement meshes.
  - **'Rebar'**: For forced detection of reinforcing bars when the absence of welded reinforcement meshes is certain or very probable.
1. If the type of reinforcement is known (welded reinforcement mesh or reinforcing bars), select the appropriate type in advance and perform the scan.
  2. Use **'Auto'** if the type of reinforcement is not known. Use the results of a representative scanning path to decide which type of reinforcement is prevalent. Recalculate, using this prevalent type of reinforcement as your preset.

Bear in mind that when the **'Detection Mode'** (**'Auto'** or **'Mesh'**) parameter is set and reinforcement meshes are detected, the preset diameter is ignored, along with the range setting, and the system assumes a reinforcement diameter of 8 mm (0.31 in).

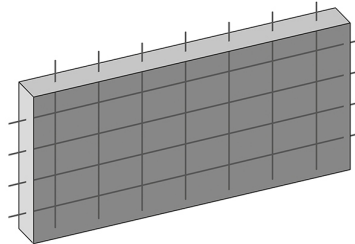

### 13.8 Special objects or configurations

In certain situations (e.g. objects very close together, object is a plate or a beam, longitudinal reinforcing bars), the cover information is given only as an approximation during the scan. Only after the scan has completed and particularly if, in addition, a reinforcing bar was located as reference, can the exact depth be calculated

and the cover information updated accordingly. Navigate to → ‘Additional Cross Section Data’ and activate the ‘Equivalent Cover’ view. This will enable you to arrive at an approximation for the cover.

## 14 Transport and storage of cordless tools

### Transport

#### CAUTION

#### Accidental starting during transport !

- ▶ Always transport your products with the batteries removed!
- ▶ Remove the battery.
- ▶ Never transport batteries in bulk form (loose, unprotected).
- ▶ Check the tool and batteries for damage before use after long periods of transport.

### Storage

#### CAUTION

#### Accidental damage caused by defective or leaking batteries !

- ▶ Always store your products with the batteries removed!
- ▶ Store the tool and batteries in a place that is as cool and dry as possible.
- ▶ Never store batteries in direct sunlight, on heating units or behind a window pane.
- ▶ Store the tool and batteries in a place where they cannot be accessed by children or unauthorized persons.
- ▶ Check the tool and batteries for damage before use after long periods of storage.

### 14.1 Care and maintenance

#### WARNING

#### Risk of injury with battery inserted !

- ▶ Always remove the battery before carrying out care and maintenance tasks!

#### Care and maintenance of the tool

- Carefully remove stubborn dirt.
- Clean the air vents carefully with a dry brush.
- Use only a slightly damp cloth to clean the casing. Do not use cleaning agents containing silicone as these can attack the plastic parts.

#### Care of the Li-ion batteries

- Keep the battery free from oil and grease.
- Use only a slightly damp cloth to clean the casing. Do not use cleaning agents containing silicone as these may attack the plastic parts.
- Avoid ingress of moisture.

#### Maintenance

- Check all visible parts and controls for signs of damage at regular intervals and make sure that they all function correctly.
- Do not operate the product if signs of damage are found or if parts malfunction. Have it repaired immediately by **Hilti Service**.
- After cleaning and maintenance, fit all guards or protective devices and check that they function correctly.



To help ensure safe and reliable operation, use only genuine Hilti spare parts and consumables. Spare parts, consumables and accessories approved by Hilti for use with the product can be found at your local **Hilti Store** or online at: [www.hilti.group](http://www.hilti.group).

### 14.2 HiltiMeasuring Systems Service

**HiltiMeasuring Systems Service** checks the scanning tool and, if deviations from the specified accuracy are found, recalibrates it and rechecks to ensure conformity with specifications. The service certificate provides written confirmation of conformity with specifications at the time of the test. The following is recommended:

- Choose a test/inspection interval that matches usage of the device.

- Have the product checked by **Hilti** Measuring Systems Service after exceptionally heavy use or subsection to unusual conditions or stress, before important work or at least once a year.

Testing and inspection by **Hilti** Measuring Systems Service does not relieve the user of the obligation to check the scanning tool before and during use.

## 15 Troubleshooting

### 15.1 Troubleshooting

If the trouble you are experiencing is not listed in this table or you are unable to remedy the problem by yourself, please contact **Hilti** Service.

Malfunction	Possible cause	Action to be taken
Scanning tool does not start.	Battery not charged.	▶ Battery has to be charged.
	Contacts on scanning tool or battery are dirty.	▶ Clean the contacts and re-insert the battery.
	Battery defective.	▶ Contact <b>Hilti</b> Service.
	The display is faulty.	▶ If the green LED in the control panel lights up but the display is blank, contact <b>Hilti</b> Service.
Error message when starting.	The  button is faulty.	▶ If the green LED in the control panel does not light up, contact <b>Hilti</b> Service.
	Self-diagnosis not successfully completed.	▶ Follow the instructions on the screen. Contact <b>Hilti</b> Service if the problem recurs.
Error message is displayed, scanning tool switches off.	Error message is displayed, scanning tool switches off.	▶ Follow the instructions on the screen. Restart the product. Contact <b>Hilti</b> Service if the problem recurs.
	Entry by means of control panel not possible	▶ Contact <b>Hilti</b> Service.
Entry by means of touchscreen not possible	Touchscreen defective	▶ Contact <b>Hilti</b> Service.
The battery doesn't engage with an audible click.	The retaining lugs on the battery are dirty.	▶ Clean the retaining lugs and refit the battery.
Scanning tool can be operated for only a short time before battery charge is exhausted	The battery is old or defective, or the maximum number of charging cycles has been exceeded	▶ Contact <b>Hilti</b> Service.
Scanning tool switches off unexpectedly.	Temperature too high.	▶ Follow the instructions on the screen. ▶ Allow the scanning tool sufficient time to cool down and then restart it.
	Voltage too high.	▶ Follow the instructions on the screen. ▶ Restart the scanning tool. Contact <b>Hilti</b> Service if the fault / error persists.
	The battery is discharged.	▶ Charge the battery. ▶ Insert a charged battery.
Wheels not running smoothly	The wheels are dirty or dusty	▶ Clean the wheels and casing.
	The drive belt or gear teeth are worn	▶ Contact <b>Hilti</b> Service.
Measurement of the distance covered is not correct	The scan was made too close to a side wall, wheels braked or accelerated by contact with the wall.	▶ Keep the scanner clear of the side wall.

Malfunction	Possible cause	Action to be taken
Measurement of the distance covered is not correct	Uneven or rough surface	► Lay a thin, even sheet or board on the surface.
	The wheels are dirty or dusty	► Clean the wheels and casing.
	Internal encoders out of position following an impact or a drop.	► Perform an encoder test. Contact <b>Hilti Service</b> if the result is out of tolerance.
Accuracy of measurement for depth of concrete cover, diameter and object localization is below expectations.	Sources of external interference in the vicinity.	<ul style="list-style-type: none"> <li>► Check whether the interference indicator is switched on.</li> <li>► If possible, eliminate external sources of interference. Also refer to the section headed Restrictions on scanning performance → page 11.</li> </ul>
	Scanning tool not calibrated or influenced.	<ul style="list-style-type: none"> <li>► Re-calibrate the scanning tool.</li> <li>► If the problem persists, compare scans of similar structures and perform a plausibility check.</li> </ul>
No objects visible in the preview area.	The depth of cover over the objects is outside the preset layer thickness range.	► Use  to adjust the layer of thickness range.
Data cannot be transmitted	Connecting cable is defective	► Change the connecting cable or contact <b>Hilti Service</b> .
	Interface on PS 300 or PSA 200 is defective	► Contact <b>Hilti Service</b> .
	WiFi connection interrupted	► Re-establish the WiFi connection.
	WiFi devices are too far apart.	► Reduce the distance between data transmitter and data receiver.
	WiFi configuration incorrect.	► Check your network configuration.
Slow data transfer via WiFi.	WiFi data traffic too heavy.	► Reduce the data traffic in your network.

## 16 RoHS (Restriction of Hazardous Substances)

Click on the link to go to the table of hazardous substances: [qr.hilti.com/r9374764](http://qr.hilti.com/r9374764). There is a link to the RoHS table, in the form of a QR code, at the end of this document.

## 17 Disposal



### WARNING

**Risk of injury.** Hazards presented by improper disposal.

- Improper disposal of the equipment may have the following consequences: The burning of plastic components generates toxic fumes which may present a health hazard. Batteries may explode if damaged or exposed to very high temperatures, causing poisoning, burns, acid burns or environmental pollution. Careless disposal may permit unauthorized and improper use of the equipment. This may result in serious personal injury, injury to third parties and pollution of the environment.
- Dispose of defective batteries right away. Keep them out of reach of children. Do not disassemble or incinerate the batteries.
- Batteries that have reached the end of their life must be disposed of in accordance with national regulations or returned to **Hilti**.



Most of the materials from which **Hilti** tools and appliances are manufactured can be recycled. The materials must be correctly separated before they can be recycled. In many countries, your old tools,

machines or appliances can be returned to **Hilti** for recycling. Ask **Hilti** Service or your Hilti representative for further information.

## 18 Manufacturer's warranty

- ▶ Please contact your local **Hilti** representative if you have questions about the warranty conditions.

## 19 FCC statement (applicable in US) / IC statement (applicable in Canada)



This device has been tested and found to comply with the limits for a class A digital device, pursuant to part 15 of the FCC rules. These limits are intended to ensure adequate protection against electromagnetic interference when the device is operated in areas used for commercial purposes. This equipment generates, uses, and can radiate radio frequency energy and, if not installed and used in accordance with the instructions, may cause interference to radio communications. The user must bear costs incurred due to interference that operation of this device in residential areas can cause.

This device is in compliance with paragraph 15 of the FCC rules and the RSS-210 specifications of ISED. Operation is subject to the following two conditions:

- This device shall cause no harmful interference.
- This device must accept any interference received, including interference that may cause undesired operation.



Changes or modifications not expressly approved by **Hilti** may restrict the user's authorization to operate the equipment.

## 20 Tolerances of reinforcing bars

The following results were obtained under laboratory conditions with single reinforcing bars (minimum rebar spacing 50 cm) without the influence of external electromagnetic fields. The accuracy of cover measurements can differ when scanning is performed under real-life conditions.

### Key to the symbols used in the tables

∅ mm	Diameter (in millimeters)
↓ mm	Depth / cover (in millimeters)
±	The value represents the typical accuracy with which depth of cover is measured (deviation from the actual value in millimeters).
0	The reinforcing bar is visible at this depth, but cover is not calculated.
X	The reinforcing bar is not visible at this depth.

### DIN 488

∅ mm	↓ mm									
	20	40	50	60	80	100	120	150	180	200
6	± 1	± 1	± 1	± 2	± 3	± 4	± 5	x	x	x
8	± 1	± 1	± 1	± 2	± 3	± 4	± 5	x	x	x
10	± 1	± 1	± 1	± 2	± 3	± 4	± 5	0	x	x
12	± 1	± 1	± 1	± 2	± 3	± 4	± 5	± 7	x	x
14	± 1	± 1	± 1	± 2	± 3	± 4	± 5	± 7	x	x
16	± 1	± 1	± 1	± 2	± 3	± 4	± 5	± 7	0	x
20	± 1	± 1	± 1	± 2	± 3	± 4	± 5	± 7	± 9	0
25	± 1	± 1	± 1	± 2	± 3	± 4	± 5	± 7	± 9	± 9
28	± 1	± 1	± 1	± 2	± 3	± 4	± 5	± 7	± 9	± 9
32	± 1	± 1	± 1	± 2	± 3	± 4	± 5	± 7	± 9	± 9
40	± 1	± 1	± 1	± 2	± 3	± 4	± 5	± 7	± 9	± 9

**ASTM**

Ø mm	↓ mm									
	20	40	50	60	80	100	120	150	180	200
#3	± 1	± 1	± 1	± 2	± 3	± 4	± 5	x	x	x
#4	± 1	± 1	± 1	± 2	± 3	± 4	± 5	± 6	x	x
#5	± 1	± 1	± 1	± 2	± 3	± 4	± 5	± 6	x	x
#6	± 1	± 1	± 1	± 2	± 3	± 4	± 5	± 6	± 9	x
#7	± 1	± 1	± 1	± 2	± 3	± 4	± 5	± 6	± 9	x
#8	± 1	± 1	± 1	± 2	± 3	± 4	± 5	± 6	± 9	± 9
#9	± 1	± 1	± 1	± 2	± 3	± 4	± 5	± 6	± 9	± 9
#10	± 1	± 1	± 1	± 2	± 3	± 4	± 5	± 6	± 9	± 9
#11	± 1	± 1	± 1	± 2	± 3	± 4	± 5	± 6	± 9	± 9
#14	± 1	± 1	± 1	± 2	± 3	± 4	± 5	± 6	± 9	± 9
#18	± 1	± 1	± 1	± 2	± 3	± 4	± 5	± 6	± 9	± 9

**JIS**

Ø mm	↓ mm									
	20	40	50	60	80	100	120	150	180	200
D6	± 1	± 1	± 1	± 2	± 3	± 4	± 5	x	x	x
D10	± 1	± 1	± 1	± 2	± 3	± 4	± 5	± 7	x	x
D13	± 1	± 1	± 1	± 2	± 3	± 4	± 5	± 7	x	x
D16	± 1	± 1	± 1	± 2	± 3	± 4	± 5	± 7	x	x
D19	± 1	± 1	± 1	± 2	± 3	± 4	± 5	± 7	± 9	x
D22	± 1	± 1	± 1	± 2	± 3	± 4	± 5	± 7	± 9	x
D25	± 1	± 1	± 1	± 2	± 3	± 4	± 5	± 7	± 9	0
D29	± 1	± 1	± 1	± 2	± 3	± 4	± 5	± 7	± 9	0
D32	± 1	± 1	± 1	± 2	± 3	± 4	± 5	± 7	± 9	0
D35	± 1	± 1	± 1	± 2	± 3	± 4	± 5	± 7	± 9	0
D38	± 1	± 1	± 1	± 2	± 3	± 4	± 5	± 7	± 9	0
D41	± 1	± 1	± 1	± 2	± 3	± 4	± 5	± 7	± 9	0
D51	± 1	± 1	± 1	± 2	± 3	± 4	± 5	± 7	± 9	0







**Hilti Corporation**  
Feldkircherstraße 100  
9494 Schaan | Liechtenstein

**PS 300 (01)**

[2016]

2014/30/EU

EN 62368-1: 2014

2011/65/EU

EN ISO 12100

Schaan, 07/2018

**Paolo Luccini**

Head of Quality and  
Process-Management  
BA Electric Tools & Accessories

**Thomas Hillbrand**

Head of BU Measuring Systems  
Business Unit Measuring Systems



**Hilti Corporation**  
Feldkircherstraße 100  
9494 Schaan | Liechtenstein

**PS 300-W (01)**

[2016]

2014/53/EU

EN ISO 12100

2011/65/EU

EN 62368-1: 2014

EN 62311: 2008

EN 300328 V2.1.1

EN 301893 V2.1.1

EN 301489-1 V2.2.0

EN 301489-17 V3.2.0

Schaan, 07/2018

**Paolo Luccini**

Head of Quality and  
Process-Management  
BA Electric Tools & Accessories

**Thomas Hillbrand**

Head of BU Measuring Systems  
Business Unit Measuring Systems



PS 300





Hilti Corporation  
LI-9494 Schaan  
Tel.:+423 234 21 11  
Fax:+423 234 29 65  
[www.hilti.group](http://www.hilti.group)



2164701



Hilti Connect