



# DX 9-HSN DX 9-ENP

Quick Start Guide – Supplement



SAFETY FIRST		3
TOOL ANATOMY		4-6
SELECTING THE RIGHT NAIL, TOOL & CARTRIDGE		7
DOWNLOADING & USING THE HILTI CONNECT APP	DOWNLOAD	8
	ACCESS TOOL INFORMATION	9
FASTENING METAL DECK TO THE STEEL STRUCTURE	INSTALLING THE DECKING NAIL	10-11
	UNDERSTANDING THE SERVICE INDICATOR	12
	CONNECTING TO HILTI CONNECT VIA BLUETOOTH	13
KNOWING HOW TO CLEAN THE TOOL		14-15
KNOWING ESSENTIAL FIELD TROUBLE SHOOTING	POSSIBLE CAUSES	16-17
	TOOL STAYS COMPRESSED	18-19
	TOOL CANNOT BE COMPRESSED	20-21

Additional resources available are:

- Quick start guide
- Tool Operating Instructions
- How to video (use the resources in the Hilti Connect App, Hilti online or Hilti channel in YouTube)

**1**

### Requirements to be met by the user

The tool is intended for professional use. The tool may be operated, serviced and maintained only by trained, authorized personnel who have received special instruction regarding the hazards that may be encountered.

Use the tool for the first time only after you have been trained by a Hilti specialist on how to use it safely.

**2**

### Personal Protective Equipment (PPE)

Operator and bystanders must wear helmet, eye and ear protection. Hilti recommends the operator wear hand gloves. In addition, all the jobsite safety requirements (steel toe safety shoes, safety harness, high visibility vest, etc.), deemed necessary by the local regulations and jobsite requirements must be adhered to.

**3**

### Personal safety

- Never tamper with or modify the tool in any way.
- Do not use the tool for purposes for which it was not intended.
- Stay alert, watch what you are doing and use common sense when operating the tool. Do not use the tool if you are not concentrating.
- To reduce the risk of injury use only genuine Hilti accessories and spare parts or those of equivalent quality.
- Use only fasteners of a type approved for use with the tool.
- Observe the information printed in the operating instructions concerning operation, care and maintenance.
- Never point the tool toward yourself or other persons.
- Never press the nosepiece of the tool against your hand or against any other part of your body (or other persons hand or part of their body).
- Drive the fasteners only into structural steel members. Do not attempt to drive fasteners into other materials or into hardened or brittle steel, cast iron or spring steel.
- Pull the trigger only when the nosepiece of the tool is in contact with the working surface and the tool is fully compressed.
- When driving fasteners, always hold the fastening tool at right angles to the working surface in order to help prevent the fastener being deflected by the surface.
- Never redrive a fastener, as this may cause the fastener to brake.
- Keep the grips dry, clean and free from oil and grease.
- Never leave a loaded tool unattended.
- Always remove the cartridges before cleaning, servicing or carrying out maintenance work on the tool.
- Never leave the tool unattended.
- When not in use, the tool should be unloaded (cartridge strips removed) and stored in a locked, dry place where it is inaccessible to children.
- Never compress the tool while operating the Pawl, as this presents a risk of injury to the operators hand.
- Remove the cartridge strip from the tool carefully. Never attempt to pry a cartridge from the magazine strip or tool.
- Do not disassemble the tool while it is hot. If this is unavoidable, wear protective gloves.
- Store unused cartridges in a dry place, where they are locked away or high up and out of reach of children.
- Do not operate the tool when parts are damaged or when the controls do not function correctly. Have the tool repaired by Hilti Tool Service.
- Always use the protective cap for tasks that can produce flying splinters.

Information here is general: read the operating instructions for complete details

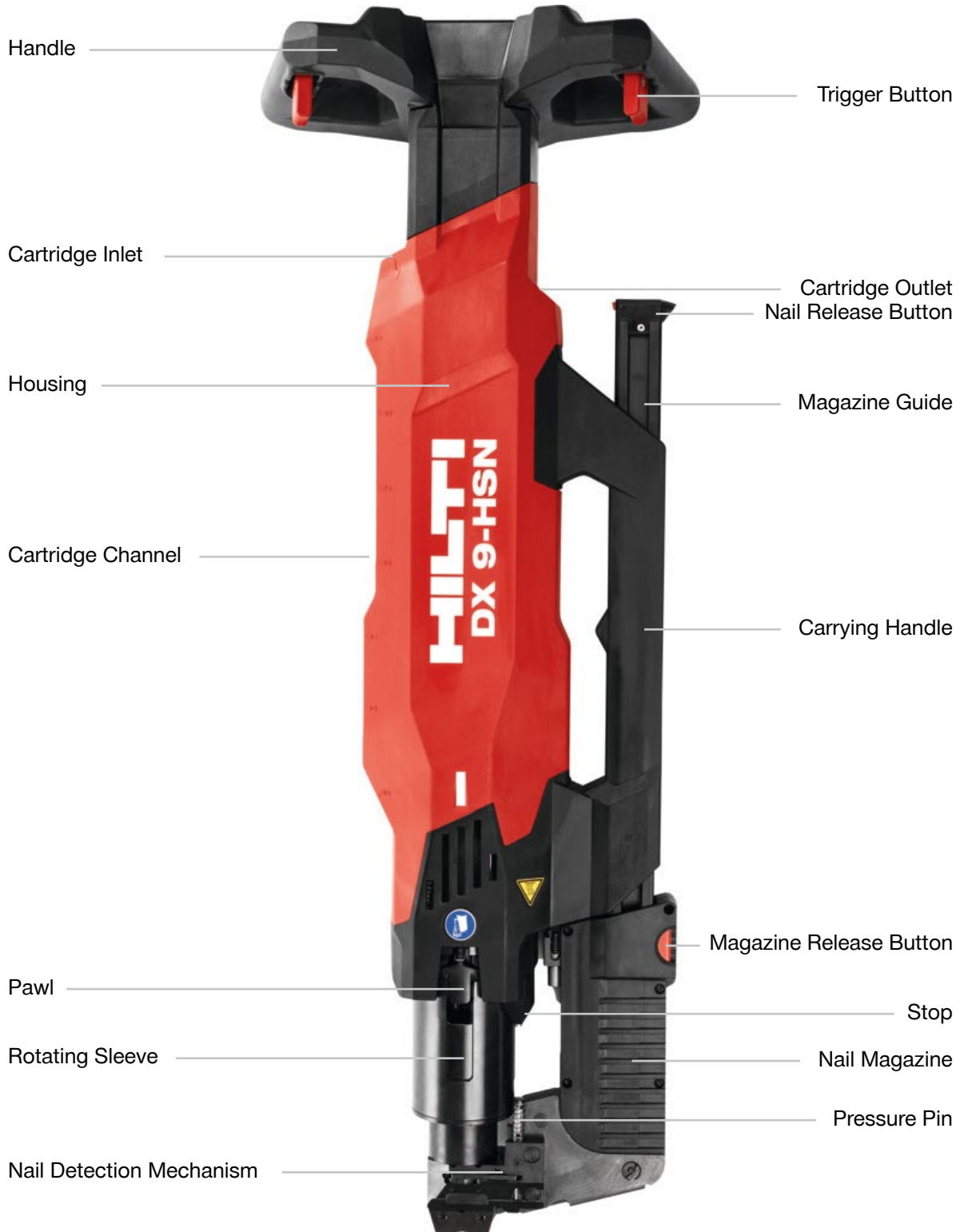



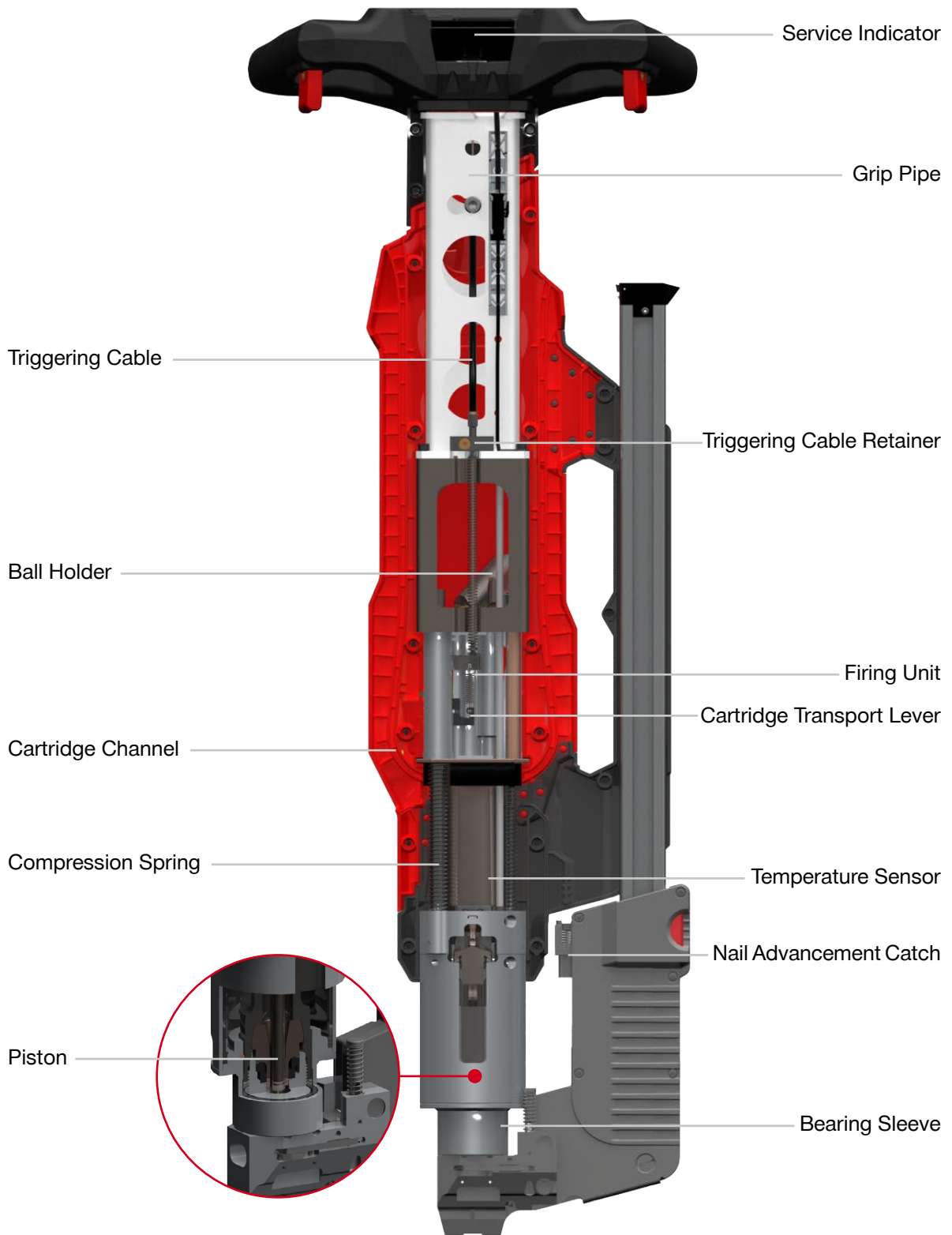

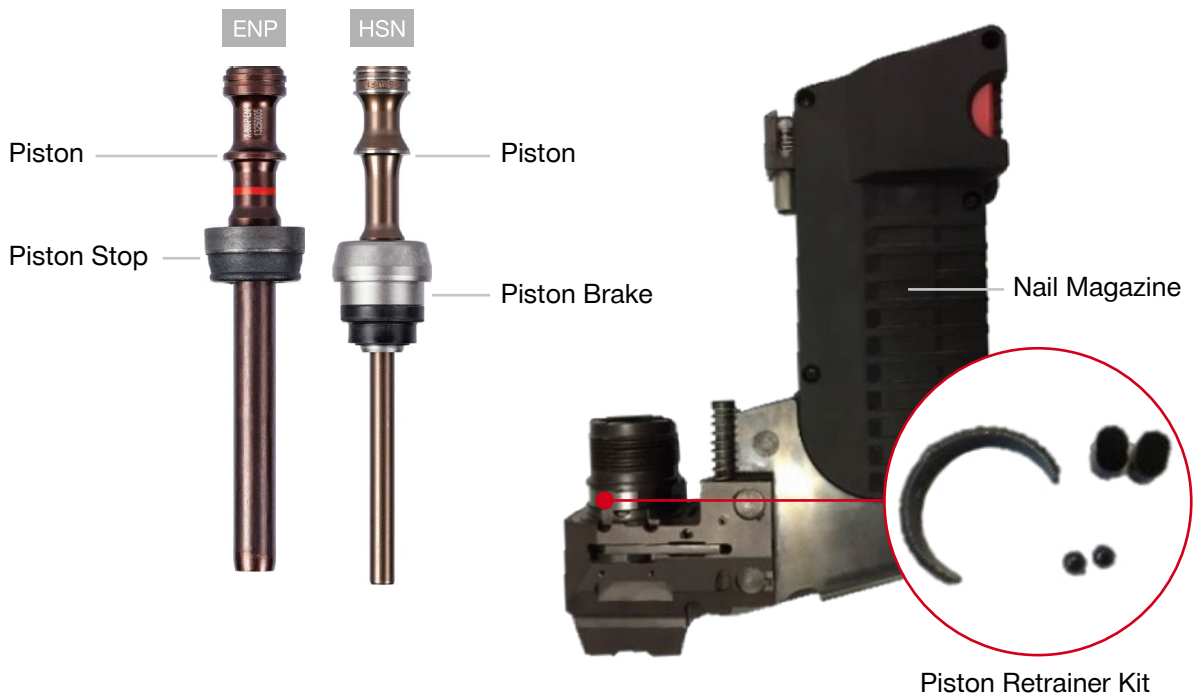
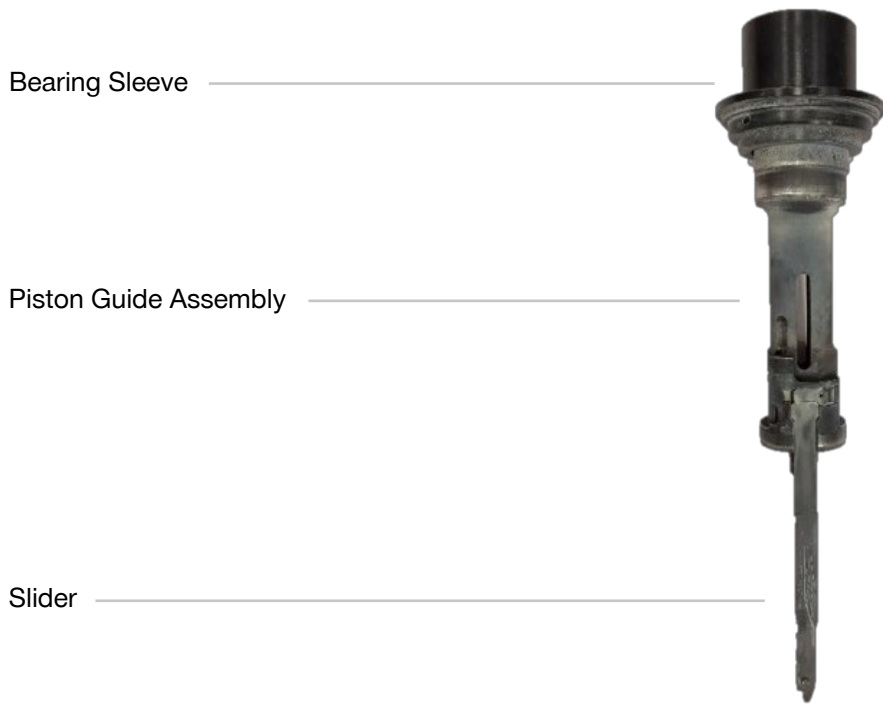

Selecting the right nail, tool and cartridge is a pre-requisite for good quality fastening. In addition, improper selection can lead to excessive wear on the DX 9 deck fastening tool.

**1 HSN**

**Select the right nail**

X-HSN 24 fastener is used for fastening deck to bar joist and light gauge steel structure in the thickness range 1/8" (3.2 mm) to 3/8" (9.6 mm).



**1 ENP**

**Select the right nail**

X-ENP-19 L15MXR fastener is used for fastening deck to structural steel 1/4" (6.4 mm) to full steel.



A fastener selection guide is available to aid in selecting the right nail if doubtful. It is included in every DX 9 tool case and can also be ordered separately.

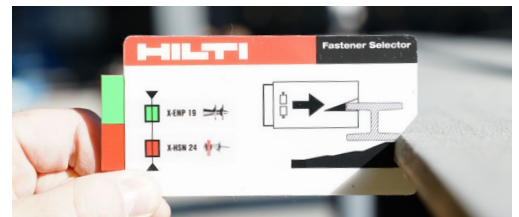
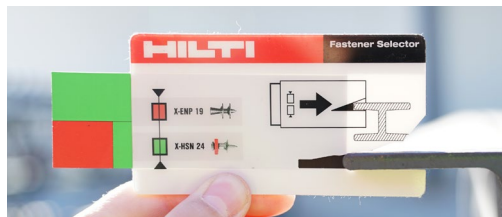

**2 HSN**

**Select the right tool**

For the X-HSN 24 nail you need to use the DX 9-HSN or the DX 860-HSN tool.



**2 ENP**

**Select the right tool**

For the X-ENP-19 L15MXR nail you need to use the DX 9-ENP or the DX 860-ENP tool.



See below reference chart to select the right color cartridge based on steel strength and steel thickness by nail type. The number within the box provides a quick reference for the tool power level. However, due to variability in base steel, check the nail stand-off by performing test fastenings and adjust the power level accordingly.

**3 HSN**

**Select the right cartridge**

For the X-HSN 24 nail and the DX 9-HSN or the DX 860-HSN tool you need to use the 6.8/11 M40 cartridge.



Base material thickness (inch/mm)	Standard steel	High-strength steel
	3/8" (9.6 mm)	red
5/16" (8.0 mm)		
1/4" (6.4 mm)	2	2
3/16" (4.8 mm)		
1/8" (3.2 mm)	S235, S275 E 36, ST 37, 340-470 N/mm <sup>2</sup>	S355, S275 E 42, ST 52, 490-630 N/mm <sup>2</sup>

**3 ENP**

**Select the right cartridge**

For the X-ENP-19 L15MXR nail and DX 9-ENP or the DX 860-ENP tool you need to use the 6.8/18 M40 cartridge.



Base material thickness (inch/mm)	Standard steel	High-strength steel
	>3/4" (19.0 mm)	4
5/8" (16.0 mm)	3	3
3/8" (9.6 mm)	4 blue	4 red
5/16" (8.0 mm)		
1/4" (6.4 mm)	3	3
	S235, S275 E 36, ST 37, 340-470 N/mm <sup>2</sup>	S355, S275 E 42, ST 52, 490-630 N/mm <sup>2</sup>

1

### App Store

Go to the Google Play Store or the Apple App Store on your phone or scan the QR code.

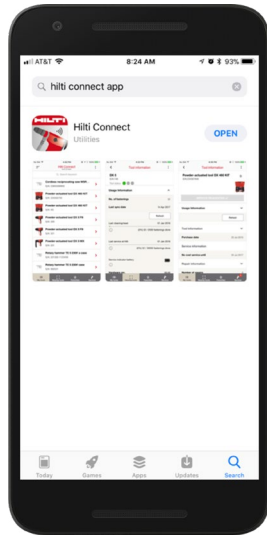

2

### Install

Search for the Hilti Connect App and install it.

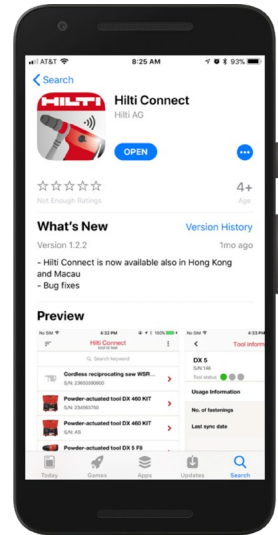

3

### Select the country

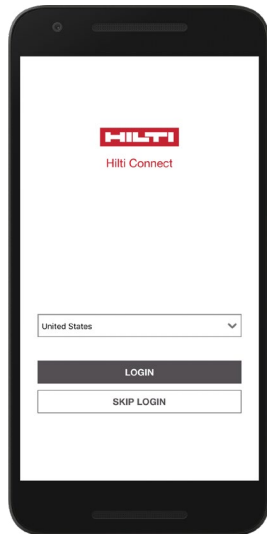

4

### Login

If you are an existing user, you can push Login. If you are a new user, you can push register or you can skip the login and use the limited functionality.

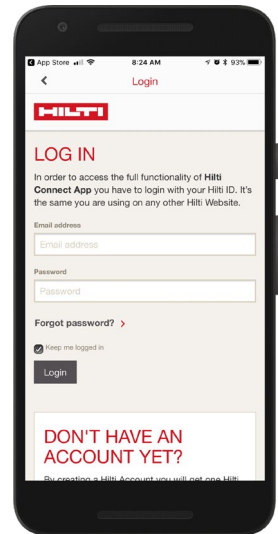

5 A

**Customers Owned/  
Fleet**

- Usage Information
- Last seen location
- Purchase information
- Service information
- Repair information

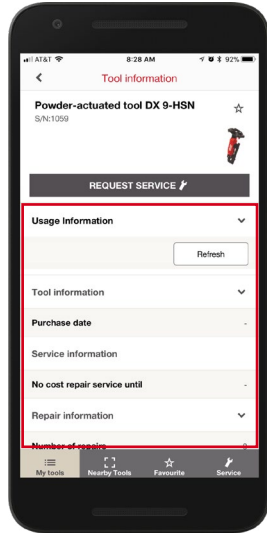

5 B

**Tool on Demand**

- Usage Information
- Last seen location

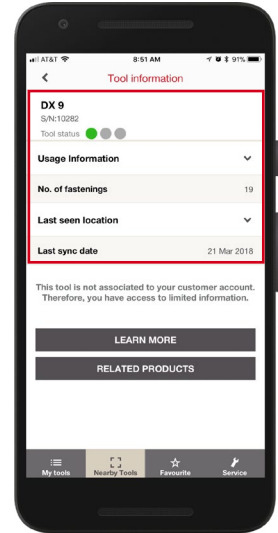

6 A

**Call to action**

- Request service
- Related product
- Learn more

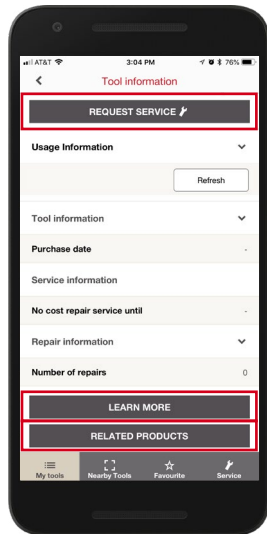

6 B

**Call to action**

- Learn more
- Related products

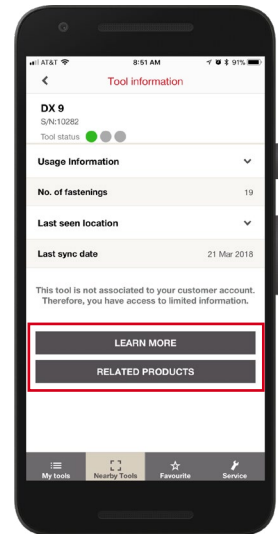

**1** HSN

**Mark the deck**

Marking the deck is important to fasten on the joist or beam because you can't see the joist or beam when fastening the deck.

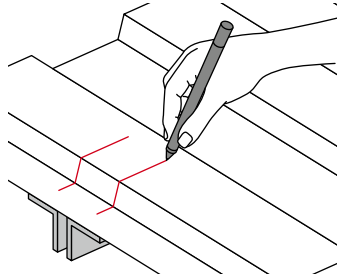

**1** ENP

**Mark the deck**

Marking the deck is important to fasten on the joist or beam because you can't see the joist or beam when fastening the deck.

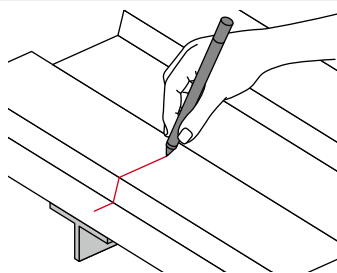

**2**

**Load the nail**

It is a good practice to always keep the Nail Magazine full. This reduces damage to the Piston Brake/Stop and subsequent damage to the Nail Detection Mechanism

Tip: For DX 9-HSN load 6 nail strips and DX 9-ENP 4 nail strips first and then always load nails when cartridge strip runs out.

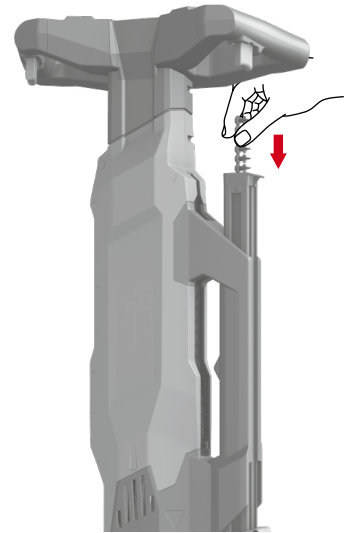

**3**

**Load the cartridge**

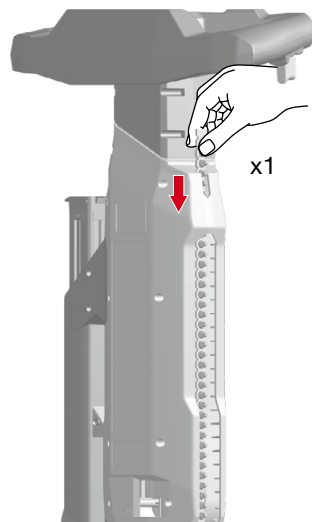

**4**

**Check cartridge strip is flush**

This step prevents missing the first cartridge on the strip.

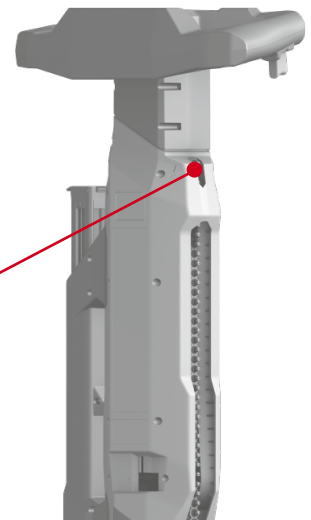
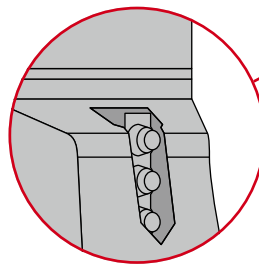

**5**

**Align tool with the deck marking**

Align the tool with the marking prior to fastening. Piston jam is a reported problem by our customers. In most cases is due to missing the joist or beam while making the fastening. Missing the joist and beam at the time of fastening can reduce the lifetime of the Piston and Piston Brake/Stop. Hence, it is important to mark the deck and align the tool with the mark while fastening.

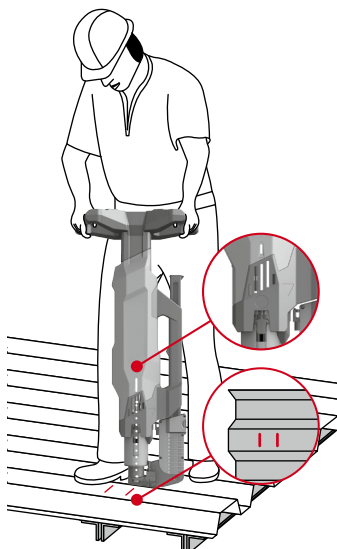

**6**

**Compress the tool and pull the trigger**

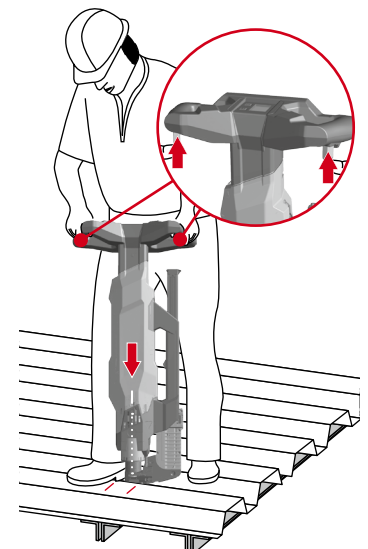

7 HSN

**Check nail stand off and adjust power level if required**

Initially, then periodically while fastening, and any time you change base material, use the Power Adjustment Gauge to check the nail stand-off and adjust the tool power level.

7.1 HSN

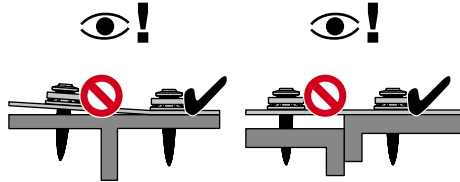

7.2 HSN

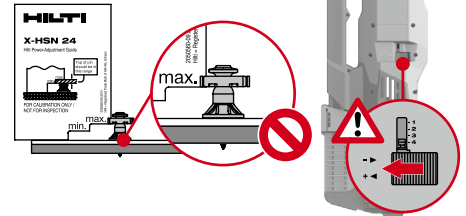

7.3 HSN

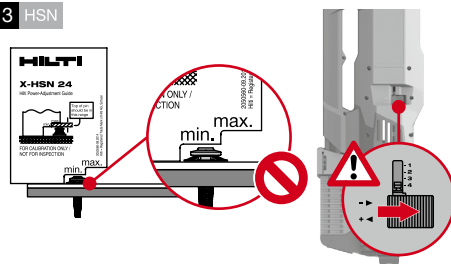

7.4 HSN

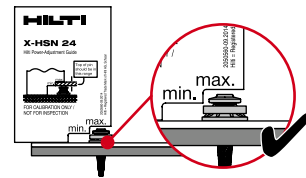

7 ENP

**Check nail stand off and adjust power level if required**

Initially, then periodically while fastening, and any time you change base material, use the Power Adjustment Gauge to check the nail stand-off and adjust the tool power level.

7.1 ENP

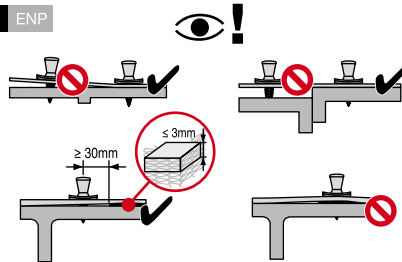

7.2 ENP

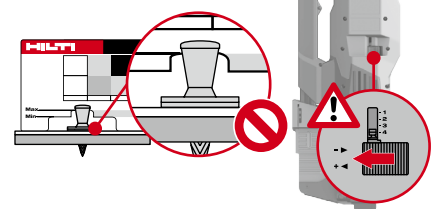

7.3 ENP

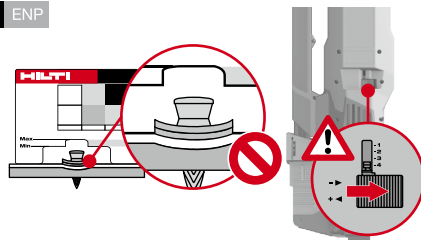

7.4 ENP

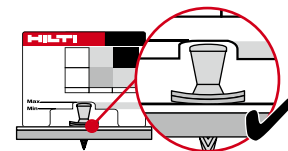



The Hilti DX 9-HSN/DX 9-ENP tool has an integrated digital Service Indicator. The digital Service Indicator on the DX 9 gives real-time feedback on when to clean and service the tool, maximizing productivity on the job. The tools operating temperature range is also displayed, helping you to work at the optimal pace.



The gauge shows the optimal operating temperature (i.e. working at optimal installation pace). A warning sign shows when the tool temperature is extremely high. A tool wrench is displayed when the tool needs to be sent to Hilti Tool Service Center for maintenance.

A large cleaning brush is displayed when the tool requires cleaning.



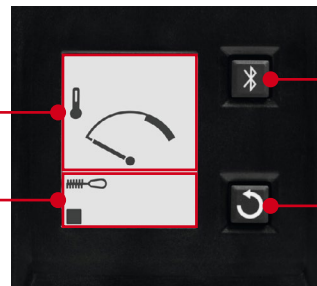





A progression bar with 7 segments indicates the number of settings since the last cleaning.

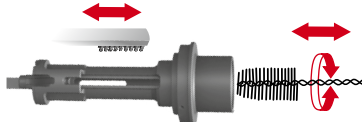
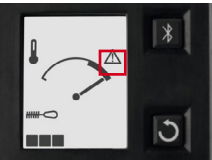

Bluetooth button

Counter reset button

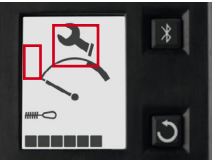
The SI displays prompts and field what it means and the action required is explained below.

Display	What it means	Action required
	Normal operation, tool cold. Fastening count progressing.	-
	Clean the tool and reset the counter after cleaning.	
	<b>WARNING:</b> Tool is extremely hot – cartridges can fire prematurely and plastic nail strips can melt if they remain stagnant while inside the tool. Cartridge and nail strips must be removed from the tool, and use of the tool must be ceased immediately until tool temperature returns to normal.	
	Tool needs maintenance. Send the tool to Hilti Tool Service Center.	 Hilti Tool Service
	Temperature sensor dysfunctional – send the tool to Hilti Tool Service Center to get the temperature sensor replaced.	 Hilti Tool Service



1

### Bluetooth

Turn on the Bluetooth on your phone.

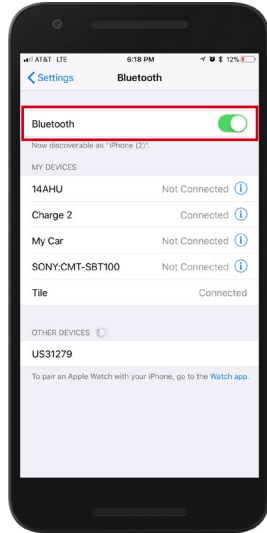

2

### Connect

Press the Bluetooth button on the digital Service Indicator > 1 sec.  
The Bluetooth on the DX 9-HSN/DX p-ENP tool turns off after 2 min.

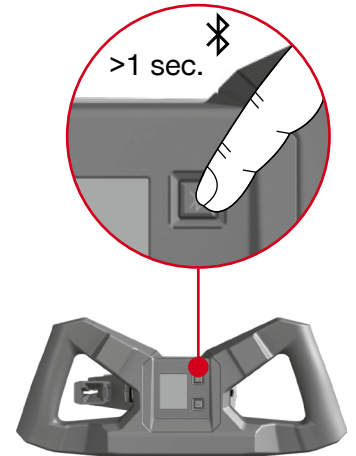

3

### Start using the Hilti Connect App

On page 9 you'll find the how to use it.

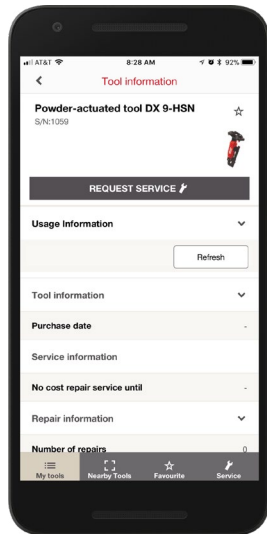

**1**

**Disassemble the tool**

Remove the cartridge strip and nails before disassembling the tool.

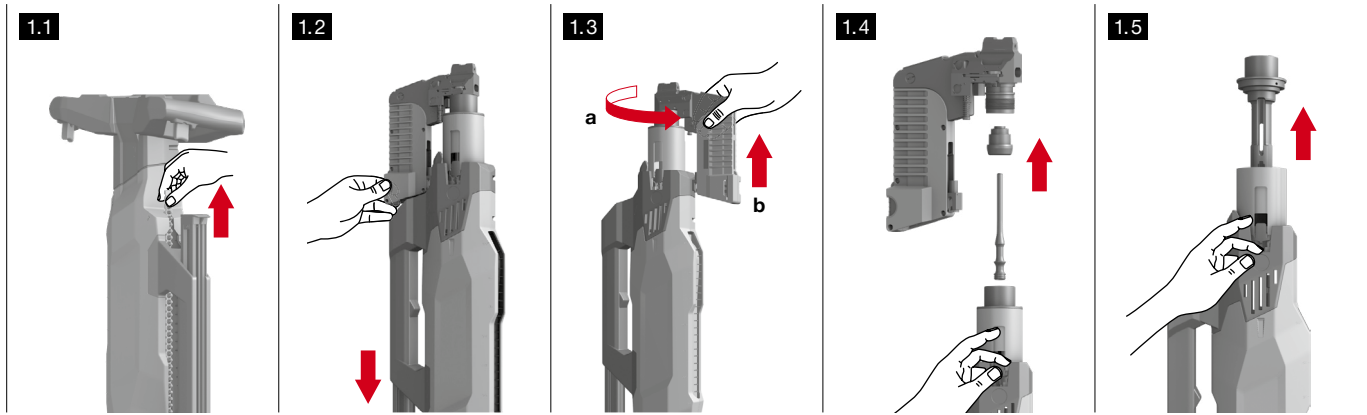

**2**

**Clean the tool**

While cleaning the tool, the Hilti spray should be applied ONLY on the Nail Magazine and NOT inside the tool.

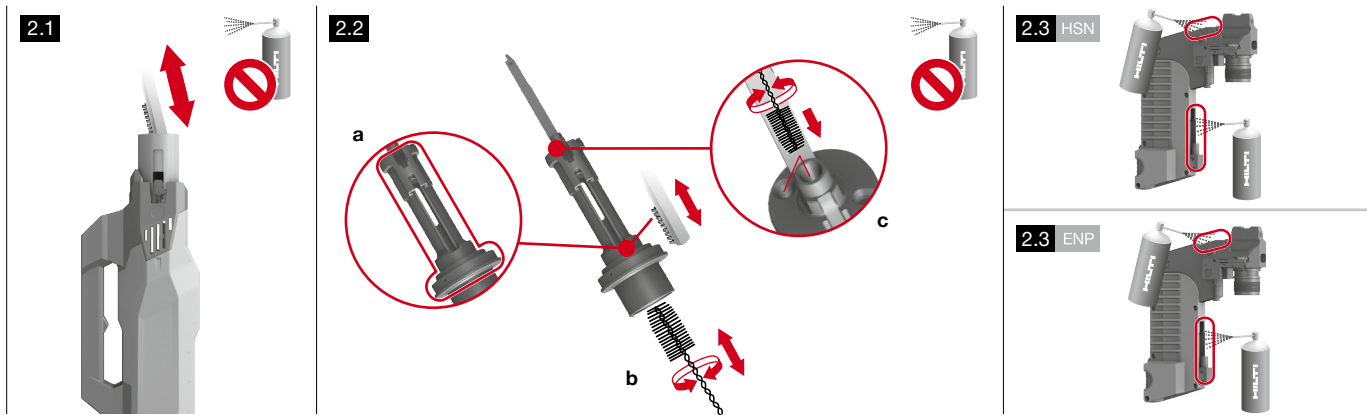

**3 HSN**

**Check the Piston and Piston Brake**

Change if either the Piston or Piston Brake is worn. Change only as a set both Piston and Piston Brake.

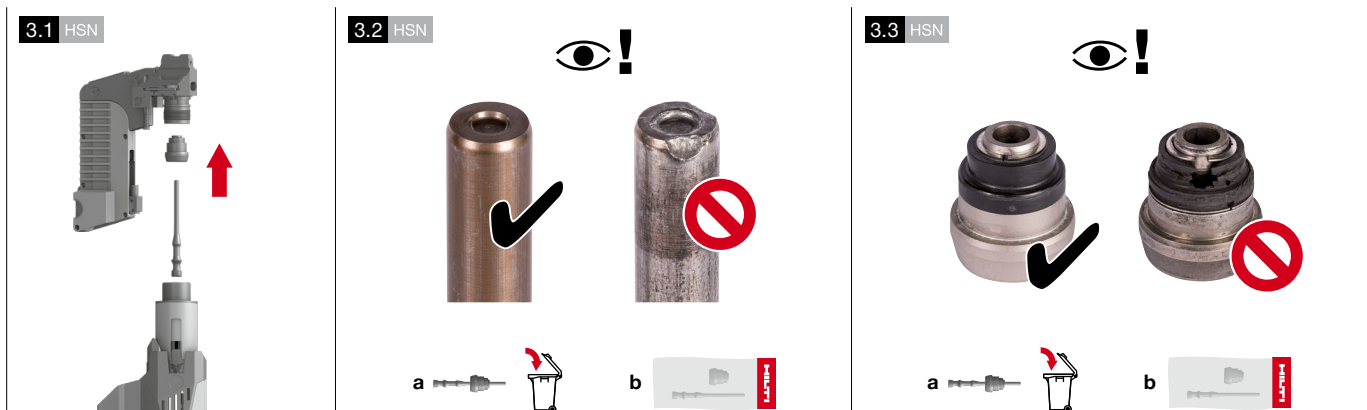

**3** ENP

**Check the Piston and Piston Stop**

Change if either the Piston or Piston Stop is worn. Change only as a set both Piston and Piston Stop.

**3.1** ENP

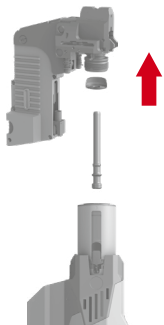

**3.2** ENP

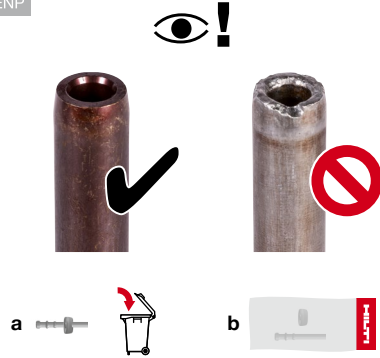

**3.3** ENP

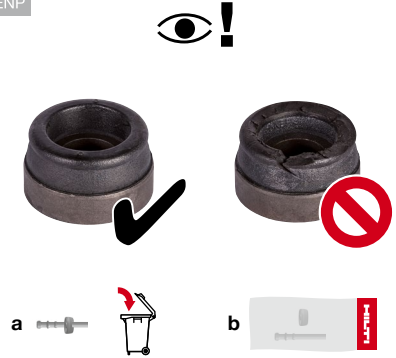

**4**

**Check the Nail Detection Mechanism**

Checking the Nail Detection Mechanism will help early diagnosis and limit the tool damage. If damaged send the Nail Magazine to Hilti Tool Service.

**4.1** HSN

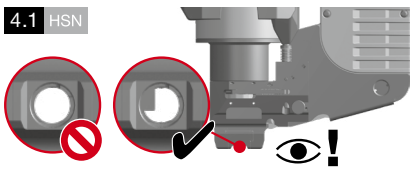

**4.2** HSN

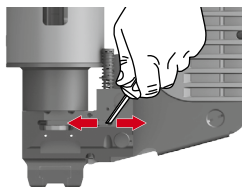

**4.3** HSN

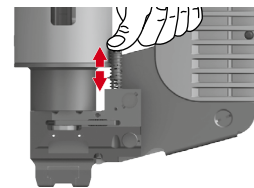

If not working  
  
Hilti Tool Service

**4.1** ENP

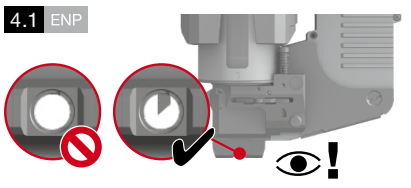

**4.2** ENP

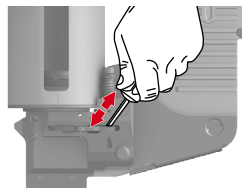

**4.3** ENP

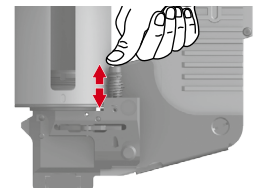

If not working  
  
Hilti Tool Service

**5**

**Assemble the tool**

Check the Piston Brake/Stop and Piston is always assembled back in.

**5.1**

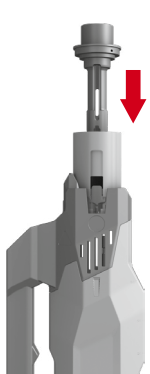

**5.2**

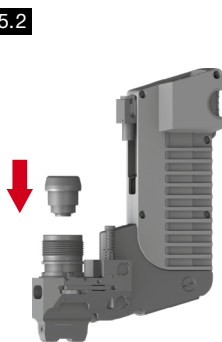

**5.3**

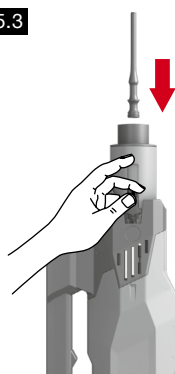

**5.4**

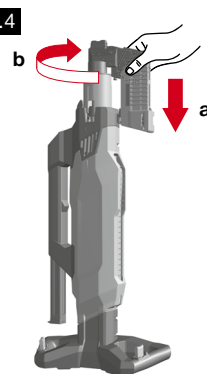

**5.5**

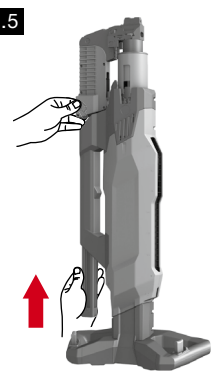

**6**

**Reset counter**

See page 12 where to reset the counter.



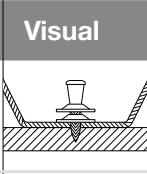
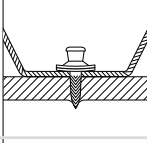
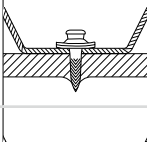
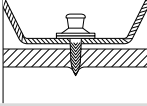
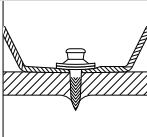

There are few instances the tool ceases to function on the jobsite. We identify below problems the customer may encounter, their possible causes and the recommended actions. Tool lifetime can be extended and higher tool performance can be achieved when the tool is cleaned and checked at regular intervals.

Problem	Possible causes	Recommended action
<b>Tool stays compressed</b>	Piston stuck due to missing the joist/steel beam	see page 18 – 19
	Piston Brake/Stop missing	Send <b>Nail Magazine</b> to Hilti Tool Service Center
	Inside of Rotating Sleeve not cleaned regularly	Send <b>DX 9 Tool</b> to Hilti Tool Service Center
<b>Tool cannot be compressed</b>	Ball stuck (Safety mechanism)	Send <b>DX 9 Tool</b> to Hilti Tool Service Center
	Nail Detection Mechanism damaged	Send <b>Nail Magazine</b> to Hilti Tool Service Center
	No nail or nail not positioned	see page 20 – 21
	Debris in Nail Magazine	
<b>Trigger failure</b>	No cartridge	Load cartridge and try again
	Tool hot	Remove cartridges and wait for the tool to cool down
	Trigger mechanism failed	Send <b>DX 9 Tool</b> to Hilti Tool Service Center
<b>Crushed cartridges</b>	Cartridge feeding mechanism failed	Send <b>DX 9 Tool</b> to Hilti Tool Service Center
	Tool hot and cartridge was not removed immediately	Jobsite troubleshoot – Remove cartridge stuck in base of Piston Guide Assembly
<b>Nail jams, Highly deformed nails, Nail failures</b>	Stop on housing missing	Send <b>DX 9 Tool</b> to Hilti Tool Service Center
	Nail Magazine is damaged	Send <b>Nail Magazine</b> to Hilti Tool Service Center
<b>Nail stand-off increasing need to increase power</b>	Piston Retainer Kit damaged	Send <b>Nail Magazine</b> to Hilti Tool Service Center

X-ENP-19

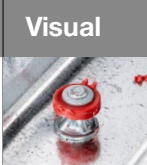
Issue	Visual	Criteria	Trouble	Possible cause	Action
Nail stand-off too high		No piston mark visible, nail head stays off, stand-off too high	Deck is not fastened properly to the beam	Power setting too low or cartridge not strong enough	Dial up power setting or increase strength of cartridge
Nail stand-off is OK		Washer compressed, piston mark clearly visible, deck flat - no deformation	-	-	-
Nail stand-off is too low		Washer over compressed, deck deformed, stand-off too low	Deck is not fastened properly to the beam	Power setting too high or cartridge is too strong	Dial down power setting or decrease strength of cartridge
Gap between deck profile and beam		Nail stand off OK or too low without piston clear mark	Deck profile does not lay solid on the beam	Gap caused by slope of the deck or local effects	Avoid gap between sheet and beam or fasten at the right side of the beam
Beam miss		Nail stand off OK or too low, sheet metal one sided deformed (edge of the beam visible)	Beam miss	Deck not marked	Mark the deck

X-HSN-24

Issue	Visual	Criteria	Trouble	Possible cause	Action
Nail stand-off too high		Top-hat not compressed, nail head stays off too high	Deck is not fastened properly to the beam	Power setting too low, or cartridge not strong enough	Dial up power setting, or increase strength of cartridge
Nail stand-off is too low		Top-hat compressed, plastic washer nearly in original shape	-	-	-
Nail stand-off is OK		Top-hat over compressed, red plastic strongly damaged	Deck is not fastened properly to the beam	Power setting too high, or cartridge is too strong	Dial down power setting, or decrease strength of cartridge
Gap between deck profile and beam		Nail stand off OK or too low, deck locally deformed	Deck profile does not lay solid on the beam	Gap caused by slope of the deck or local effects	Avoid gap between sheet and beam, or fasten at the right side of the beam
Beam miss		Nail stand off OK or too low, sheet metal deformed one sided (edge of the beam visible)	Beam miss	Deck not marked	Mark the deck

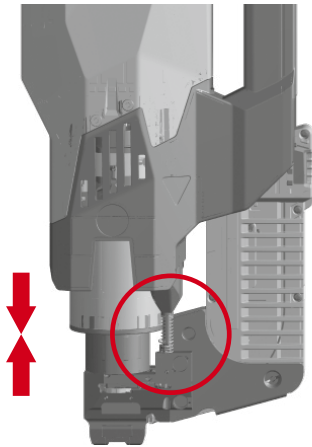

**1**

**Wait for the tool to cool down**

Wait for the tool to cool down before troubleshooting the tool. The temperature gauge on the tool can be used as a reference to check if the tool is still hot.

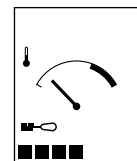
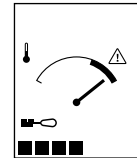

**2**

**Use the scraper and open Rotating Sleeve**

Tool should be pointing downwards while opening the Rotating Sleeve. Use only the scraper or a punch. Dont use hammer or stone as it will damage the Rotating Sleeve.

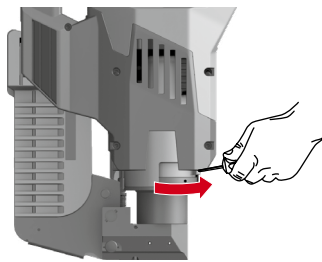

**3**

**Tool decompresses**

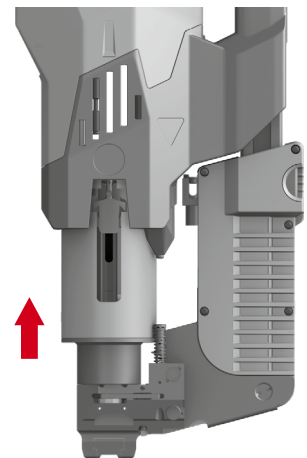

**4**

**Close the Rotating Sleeve**

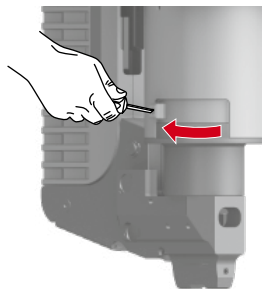

**5**

**Remove the cartridge**

When the tool is compressed the cartridges cannot be removed. Hence decompress the tool first and then remove the cartridges

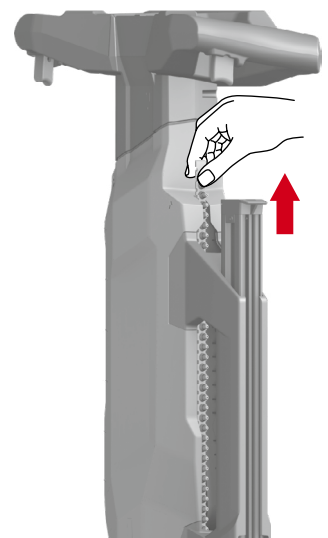

**6**  
**Release the Magazine Guide**

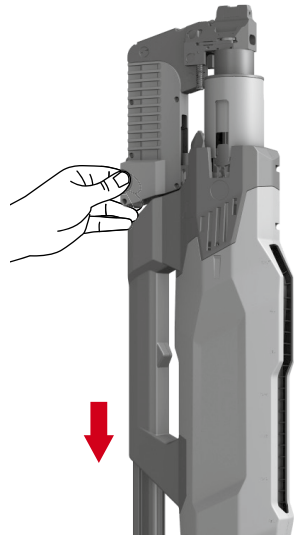

**7**  
**Disassemble the Nail Magazine**

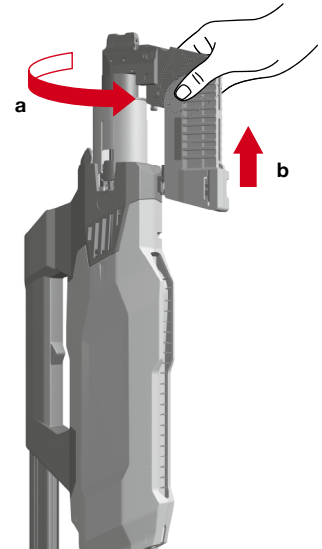

**8**  
**Replace Piston and Piston Brake/Stop**

Replace the jammed Piston and Piston Brake/Stop with a new one.

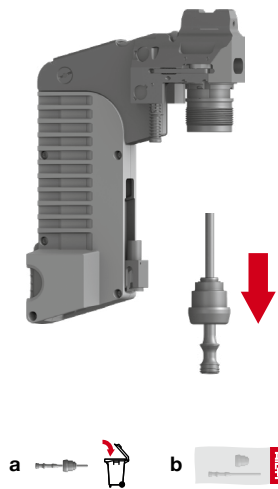

**9**  
**Assemble the tool**

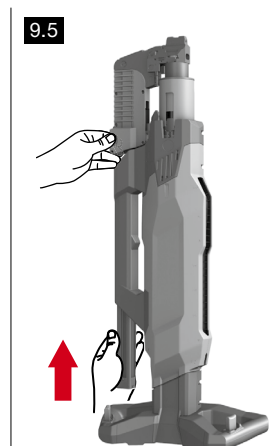
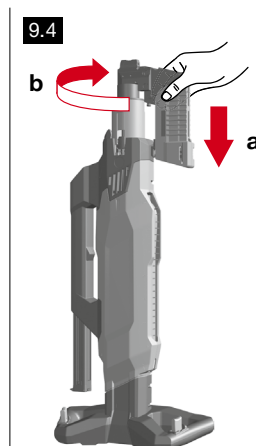
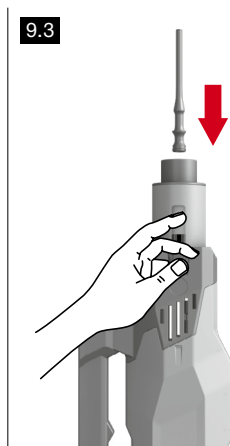
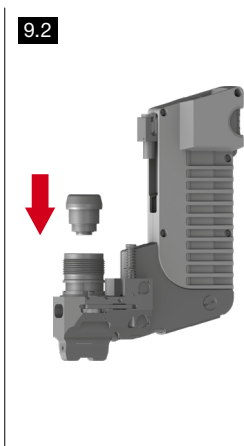
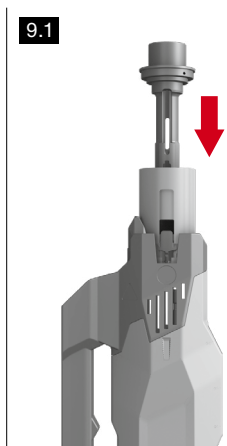



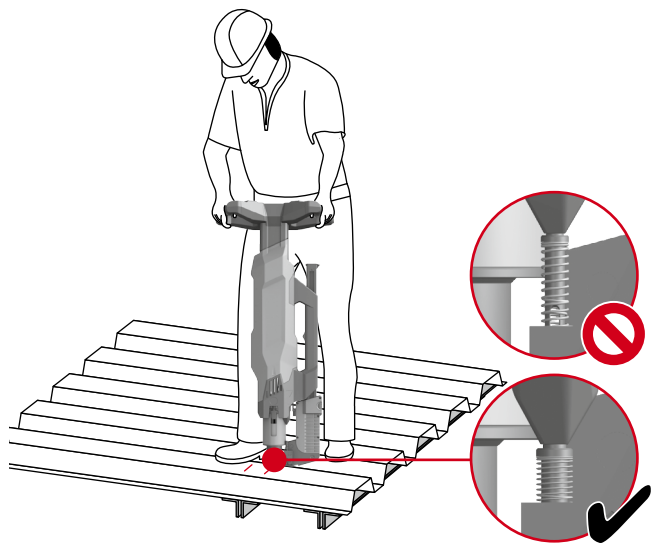

**1**  
 Remove the cartridge

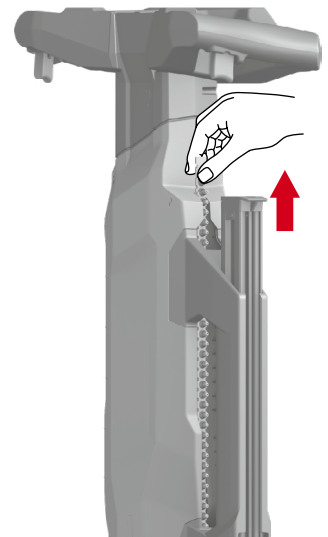

**2**  
 Insert the nails

One reason why the tool cannot be compressed is the nails are not loaded, or nails are not loaded into the right position.  
 Tip: For DX 9-HSN load 6 nail strips and DX 9-ENP 4 nail strips first and then always load the nails when cartridge strip runs out.

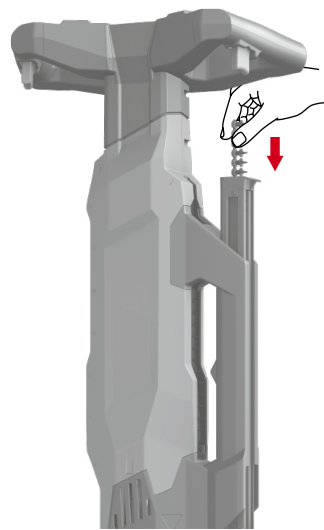

**3**  
 Visual check Pressure Pin

Try to compress the tool and visually check if the Pressure Pin is getting fully compressed.

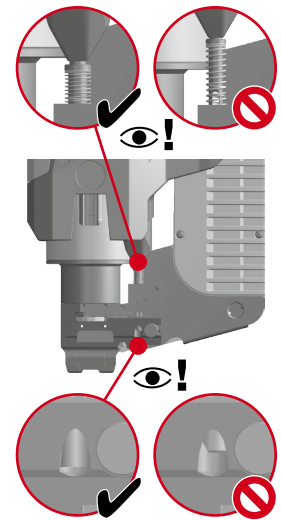

**4**  
 Remove the nails

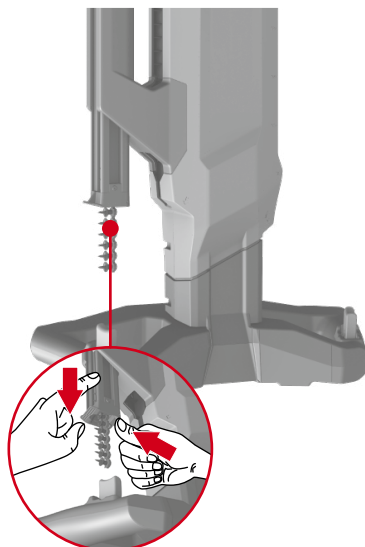

**5** HSN  
 Visually check Nail Magazine

Visually check the Nail Magazine to see if the nail detection lever is intact and visible. If broken send the Nail Magazine to Hilti Tool Service to get it fixed.

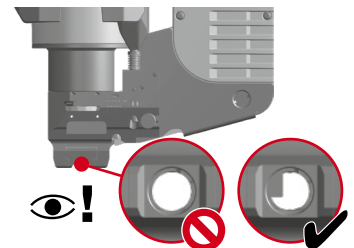

**5** ENP  
 Visually check Nail Magazine

Visually check the Nail Magazine to see if the nail detection lever is intact and visible. If broken send the Nail Magazine to Hilti Tool Service to get it fixed.

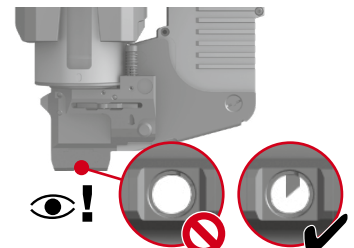



6 HSN

**Check movment of Nail Detection Mechanism**

Use the scraper and check the movement of the Nail Detection Mechanism.

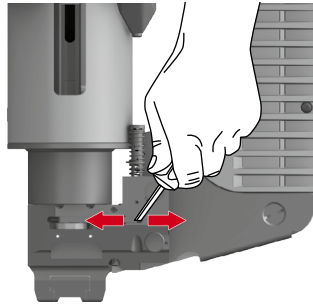

If Damaged, send the Nail Magazine to Hilti Tool Service Center.



6 ENP

**Check movment of Nail Detection Mechanism**

Use the scraper and check the movement of the Nail Detection Mechanism.

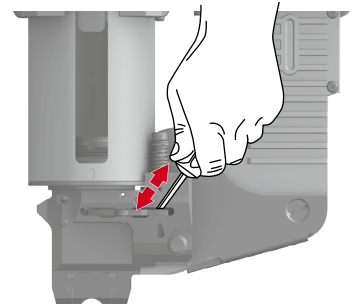

If Damaged, send the Nail Magazine to Hilti Tool Service Center.



7 HSN

**Check movement of the Pressure Pin**

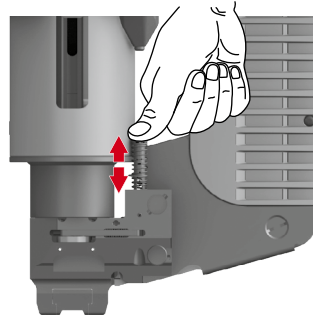

If Damaged, send the Nail Magazine to Hilti Tool Service Center.



7 ENP

**Check movement of the Pressure Pin**

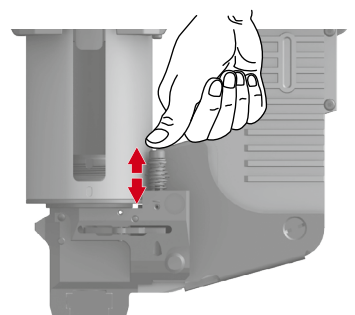

If Damaged, send the Nail Magazine to Hilti Tool Service Center.

