

HILTI

WSR 18-A

English
Français
Español
Português

en
fr
es
pt



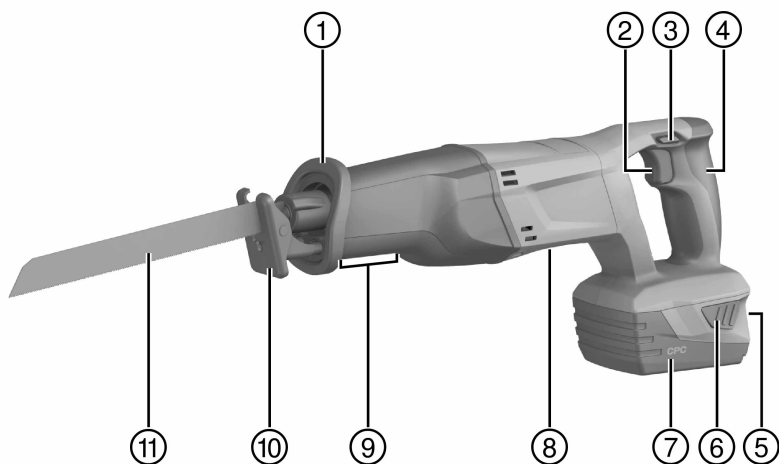

This Product is Certified
Ce produit est homologué
Producto homologado por
Este producto está registrado

2

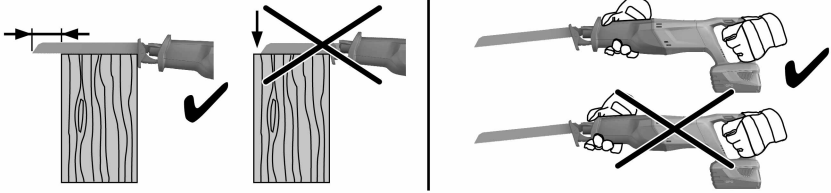

3



4

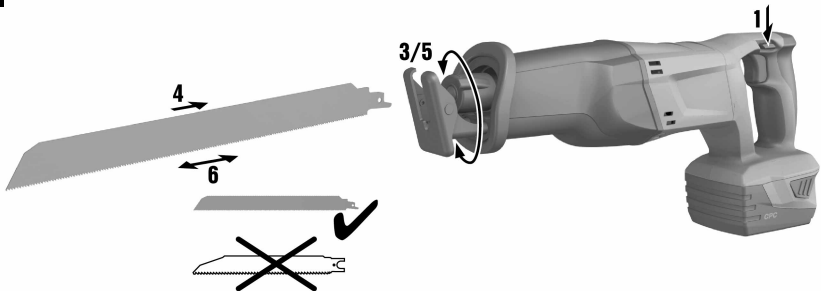

5

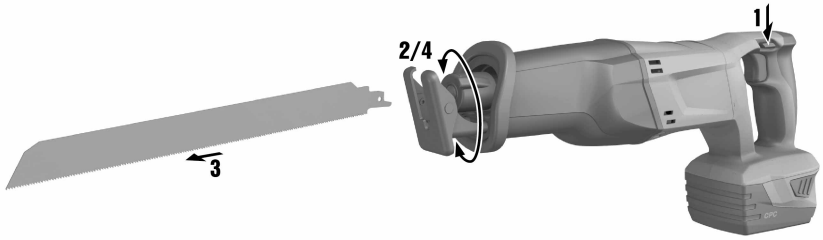

6



7

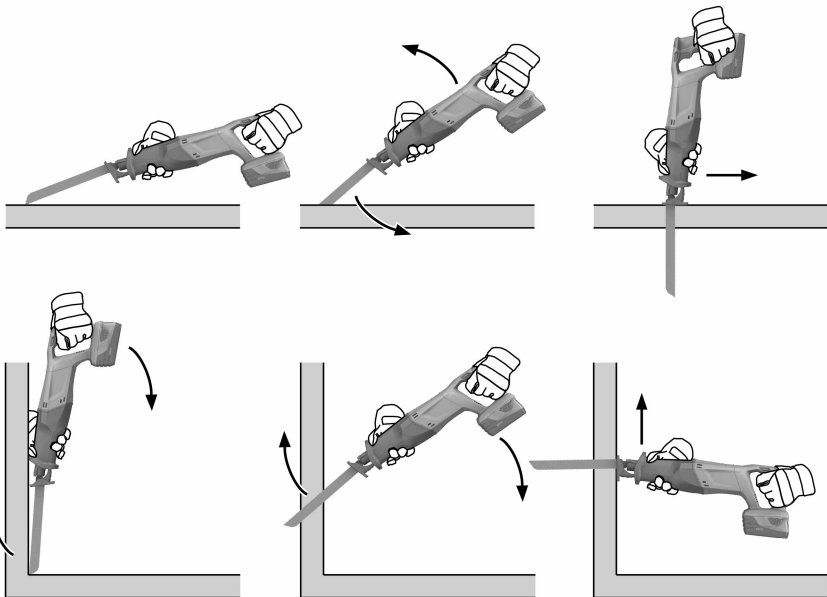

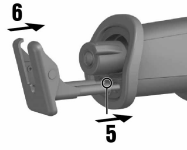
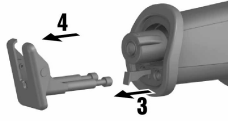

WSR 18-A



en	Original operating instructions	1
fr	Mode d'emploi original	10
es	Manual de instrucciones original	20
pt	Manual de instruções original	30

1 Information about the documentation

1.1 Explanation of signs used



1.1.1 Warnings

Warnings alert persons to hazards that occur when handling or using the product. The following signal words are used in combination with a symbol:

	DANGER! Draws attention to imminent danger that will lead to serious personal injury or fatality.
	WARNING! Draws attention to a potentially dangerous situation that could lead to serious personal injury or fatality.
	CAUTION! Draws attention to a potentially dangerous situation that could lead to slight personal injury or damage to the equipment or other property.

1.1.2 Symbols

The following symbols are used:

	Read the operating instructions before use.
	Instructions for use and other useful information
/min	Strokes per minute
n_0	Stroke rate
	Direct current (DC)

1.1.3 Illustrations

The illustrations in these operating instructions are intended to convey a basic understanding and may differ from the actual version of the product:

2	These numbers refer to the corresponding illustrations found at the beginning of these operating instructions.
3	The numbering in the illustrations reflects the order of the work steps in the illustration and may deviate from the numbering of work steps in the text.
11	Item reference numbers are used in the overview illustration. In the product overview section, the numbers shown in the legend relate to these item reference numbers.

1.2 About this documentation

- ▶ Read these operating instructions before the product is used or operated for the first time. This is a prerequisite for safe, trouble-free handling and use of the product.
- ▶ Observe the safety instructions and warnings printed in this documentation and on the tool.
- ▶ Always keep the operating instructions with the tool and make sure that the operating instructions are with the tool when it is given to other persons.

We reserve the right to make changes. Errors excepted.

1.3 Product information

Hilti products are designed for professional use and may be operated, serviced and maintained only by trained, authorized personnel. This personnel must be informed of any particular hazards that may be encountered. The product and its ancillary equipment may present hazards when used incorrectly by untrained personnel or when used not as directed.

- Make a note of the designation and serial number printed on the identification plate in the following table.
- ▶ Always quote this information when you contact a Hilti representative or Hilti Service to make an enquiry:

Product information

Reciprocating saw	WSR 18-A
Generation:	01

Serial no.:	
-------------	--

2 Safety

2.1 Safety instructions

The safety rules given in the following section contain all general safety rules for electric tools which, in accordance with the applicable standards, require to be listed in the operating instructions. Accordingly, some of the rules listed may not be relevant to this electric tool.

2.1.1 General power tool safety warnings

WARNING

Read all safety warnings and all instructions. Failure to follow the warnings and instructions may result in electric shock, fire and/or serious injury.

Save all warnings and instructions for future reference.

The term "power tool" in the warnings refers to your mains-operated (corded) power tool or battery-operated (cordless) power tool.

Work area safety

- ▶ **Keep work area clean and well lit.** Cluttered or dark areas invite accidents.
- ▶ **Do not operate power tools in explosive atmospheres, such as in the presence of flammable liquids, gases or dust.** Power tools create sparks which may ignite the dust or fumes.
- ▶ **Keep children and bystanders away while operating a power tool.** Distractions can cause you to lose control.

Electrical safety

- ▶ **Power tool plugs must match the outlet. Never modify the plug in any way. Do not use any adapter plugs with earthed (grounded) power tools.** Unmodified plugs and matching outlets will reduce risk of electric shock.
- ▶ **Avoid body contact with earthed or grounded surfaces, such as pipes, radiators, ranges and refrigerators.** There is an increased risk of electric shock if your body is earthed or grounded.
- ▶ **Do not expose power tools to rain or wet conditions.** Water entering a power tool will increase the risk of electric shock.
- ▶ **Do not abuse the cord. Never use the cord for carrying, pulling or unplugging the power tool. Keep cord away from heat, oil, sharp edges or moving parts.** Damaged or entangled cords increase the risk of electric shock.
- ▶ **When operating a power tool outdoors, use an extension cord suitable for outdoor use.** Use of a cord suitable for outdoor use reduces the risk of electric shock.
- ▶ **If operating a power tool in a damp location is unavoidable, use a residual current device (RCD) protected supply.** Use of an RCD reduces the risk of electric shock.

Personal safety

- ▶ **Stay alert, watch what you are doing and use common sense when operating a power tool. Do not use a power tool while you are tired or under the influence of drugs, alcohol or medication.** A moment of inattention while operating power tools may result in serious personal injury.
- ▶ **Use personal protective equipment. Always wear eye protection.** Protective equipment such as dust mask, non-skid safety shoes, hard hat, or hearing protection used for appropriate conditions will reduce personal injuries.
- ▶ **Prevent unintentional starting. Ensure the switch is in the off-position before connecting to power source and/or battery pack, picking up or carrying the tool.** Carrying power tools with your finger on the switch or energising power tools that have the switch on invites accidents.
- ▶ **Remove any adjusting key or wrench before turning the power tool on.** A wrench or a key left attached to a rotating part of the power tool may result in personal injury.
- ▶ **Do not overreach. Keep proper footing and balance at all times.** This enables better control of the power tool in unexpected situations.
- ▶ **Dress properly. Do not wear loose clothing or jewellery. Keep your hair, clothing and gloves away from moving parts.** Loose clothes, jewellery or long hair can be caught in moving parts.
- ▶ **If devices are provided for the connection of dust extraction and collection facilities, ensure these are connected and properly used.** Use of dust collection can reduce dust-related hazards.

Power tool use and care

- ▶ Do not force the power tool. Use the correct power tool for your application. The correct power tool will do the job better and safer at the rate for which it was designed.
- ▶ **Do not use the power tool if the switch does not turn it on and off.** Any power tool that cannot be controlled with the switch is dangerous and must be repaired.
- ▶ **Disconnect the plug from the power source and/or the battery pack from the power tool before making any adjustments, changing accessories, or storing power tools.** Such preventive safety measures reduce the risk of starting the power tool accidentally.
- ▶ **Store idle power tools out of the reach of children and do not allow persons unfamiliar with the power tool or these instructions to operate the power tool.** Power tools are dangerous in the hands of untrained users.
- ▶ **Maintain power tools. Check for misalignment or binding of moving parts, breakage of parts and any other condition that may affect the power tool's operation. If damaged, have the power tool repaired before use.** Many accidents are caused by poorly maintained power tools.
- ▶ **Keep cutting tools sharp and clean.** Properly maintained cutting tools with sharp cutting edges are less likely to bind and are easier to control.
- ▶ **Use the power tool, accessories and tool bits etc. in accordance with these instructions, taking into account the working conditions and the work to be performed.** Use of the power tool for operations different from those intended could result in a hazardous situation.

Battery tool use and care

- ▶ **Recharge only with the charger specified by the manufacturer.** A charger that is suitable for one type of battery pack may create a risk of fire when used with another battery pack.
- ▶ **Use power tools only with specifically designated battery packs.** Use of any other battery packs may create a risk of injury and fire.
- ▶ **When battery pack is not in use, keep it away from other metal objects, like paper clips, coins, keys, nails, screws or other small metal objects, that can make a connection from one terminal to another.** Shorting the battery terminals together may cause burns or a fire.
- ▶ **Under abusive conditions, liquid may be ejected from the battery; avoid contact. If contact accidentally occurs, flush with water. If liquid contacts eyes, additionally seek medical help.** Liquid ejected from the battery may cause irritation or burns.

Service

- ▶ **Have your power tool serviced by a qualified repair person using only identical replacement parts.** This will ensure that the safety of the power tool is maintained.

2.1.2 Safety instructions for jig saw / reciprocating saw

- ▶ **Hold power tool by insulated gripping surfaces, when performing an operation where the cutting accessory may contact hidden wiring.** Cutting accessory contacting a "live" wire may make exposed metal parts of the power tool "live" and could give the operator an electric shock.

2.1.3 Additional safety instructions

Personal safety

- ▶ Use clamps or another practical way to secure and support the workpiece to a stable platform. Holding the work by hand or against your body leaves it unstable and may lead to loss of control.
- ▶ **Modification of the power tool is not permitted.**
- ▶ **Wear ear protectors.** Exposure to noise can cause hearing loss.
- ▶ **Respiratory protection must be worn if the power tool is used without a dust removal system for work that creates dust.**
- ▶ **Improve the blood circulation in your fingers by relaxing your hands and exercising your fingers during breaks between working.**
- ▶ **The power tool is not intended for use by inexperienced persons who have received no special training.**
- ▶ **Keep the power tool out of reach of children.**
- ▶ **Wear protective gloves when changing accessory tools as accessory tools get hot during use and cutting edges of saw blades are sharp.**
- ▶ **Switch the product on only after bringing it into the working position.**
- ▶ **Engage the transport lock before storing or transporting the tool.**
- ▶ Avoid unintentional starting. Never carry the power tool with your finger on the control switch. Remove the battery from the power tool during work breaks, before carrying out maintenance, before changing accessory tools and before transporting the power tool.

- ▶ **Observe the national health and safety requirements.**
- ▶ Dust from materials, such as paint containing lead, some wood species, concrete / masonry / stone containing silica, and minerals as well as metal, may be harmful. Contact with or inhalation of the dust may cause allergic reactions and/or respiratory or other diseases to the operator or bystanders. Certain kinds of dust are classified as carcinogenic such as oak and beech dust, especially in conjunction with additives for wood conditioning (chromate, wood preservative). Material containing asbestos may be handled only by specialists. **Use a dust removal system whenever possible. To achieve a high level of dust collection, use a suitable vacuum cleaner. When indicated, wear a respirator appropriate for the type of dust generated. Ensure that the workplace is well ventilated. Follow national requirements for the materials you want to work with.**

Electrical safety

- ▶ **Before beginning work, check the working area (e.g. using a metal detector) to ensure that no concealed electric cables or gas and water pipes are present.** External metal parts of the power tool may become live, for example, when an electric cable is damaged accidentally. This presents a serious risk of electric shock.

Special safety instructions for reciprocating saws

- ▶ **Always guide the power tool away from your body when working with it.**
- ▶ **Never position your hands ahead of or on the saw blade.**
- ▶ **Never cut into unknown materials and keep the line of cut above and below the workpiece free of obstacles.** If the saw blade strikes an object it may cause the power tool to kick back.
- ▶ **Apply moderate pressure and select a suitable stroke rate when using the pipe-cutting adapter (accessory), especially when cutting large-diameter pipes.** This will help to prevent the power tool overheating.
- ▶ **Warning! When cutting through pipes, e.g. when carrying out demolition or installation work, check to ensure that the pipes no longer contain liquids and empty them if necessary. When cutting through pipes, hold the power tool above the level of the pipe you are cutting through.** The power tool incorporates no protective measures to prevent ingress of water or dampness. Liquids running out of pipes may cause a short circuit in the power tool.
- ▶ **Do not attempt to cut material thicker than the specified max. thickness for which the saw is designed and do not use unsuitable saw blades (reciprocating saw blades of the wrong size or not equipped with a 1/2" connection end).**

Careful handling and use of batteries

- ▶ **Observe the special guidelines applicable to the transport, storage and use of lithium-ion batteries.**
- ▶ **Do not expose batteries to high temperatures and keep them away from fire.** There is a risk of explosion.
- ▶ **Avoid ingress of moisture.** Ingress of moisture may cause a short circuit, resulting in burning injuries or fire.
- ▶ **Do not disassemble, crush or incinerate batteries and do not subject them to temperatures over 80°C (176°F).** This presents a risk of fire, explosion or injury through contact with caustic substances.
- ▶ **Never continue to use or attempt to charge damaged batteries, e.g. batteries with cracks, broken parts, bent or pushed-in / pulled-out contacts).**
- ▶ **Do not use the battery as a power source for other unspecified power tools or appliances.**
- ▶ If the battery is too hot to hold, it may be defective. **In this case, place the power tool in a non-flammable location, well away from flammable materials, where it can be kept under observation and allowed to cool down. Contact HiltiService after the battery has cooled down.**

3 Description

3.1 Overview of the product 1

- | | |
|---------------------------------|--------------------------------------|
| ① Chuck (blade holder) | ⑦ Battery |
| ② Control switch | ⑧ Rating plate |
| ③ Safety lock | ⑨ Forward gripping area (hand guard) |
| ④ Grip | ⑩ AVR contact shoe |
| ⑤ Battery charge status display | ⑪ Saw blade |
| ⑥ Battery release button | |

3.2 Use as directed

The product described is a cordless reciprocating saw. It is designed for cutting wood, wood-like materials, metals and plastics.

The product is designed for two-handed operation.

- ▶ Use only **Hilti** Li-ion batteries of the B 18 series with this product.
- ▶ Use only the **Hilti** battery chargers from the C4/36 series for these batteries.

3.3 Possible misuse

- ▶ Do not use the power tool to cut bricks, concrete, cellular concrete, natural stone or tiles.
- ▶ Do not use the product to cut pipes that still contain liquids.
- ▶ Do not saw into unknown materials.

3.4 Lithium-ion battery status display

The charge status of the Li-ion battery and malfunctions of the power tool are indicated by the display on the Li-ion battery. The charge status of the Li-ion battery is displayed after pressing one of the two battery release buttons.

Status	Meaning
4 LEDs light up.	• Charge status: 75 % to 100 %
3 LEDs light up.	• Charge status: 50 % to 75 %
2 LEDs light up.	• Charge status: 25 % to 50 %
1 LED lights.	• Charge status: 10 % to 25 %
1 LED blinks.	• Charge status: < 10 %
1 LED blinks, the power tool is not ready for use.	• The battery has overheated or is completely discharged.
4 LEDs blink, the power tool is not ready for use.	• The power tool is overloaded or has overheated.



Note

Battery charge status cannot be displayed while the control switch is pressed and for up to 5 seconds after releasing the control switch. If the battery display LEDs blink, please observe the instructions given in the Troubleshooting section.

3.5 Items supplied

Reciprocating saw, operating instructions.



Note

To help ensure safe and reliable operation, use only genuine Hilti spare parts and consumables. Spare parts, consumables and accessories approved by Hilti for use with the product can be found at your local **Hilti** Center or online at: www.hilti.com

4 Technical data

4.1 Reciprocating saw

	WSR 18-A
Rated voltage	21.6 V
Weight	8.4 lb (3.8 kg)
Stroke rate	0 rpm ... 3,000 rpm
Stroke	1.1 in (28 mm)
Keyless chuck for standard accessory tools	1/2 in

5 Operation

5.1 Safe operation 2



CAUTION

Risk of injury! Inadvertent starting of the product.

- ▶ Remove the battery before making any adjustments to the power tool or before changing accessories.



WARNING

Risk of injury! Risk of kickback.

- ▶ Always use saw blades of adequate length. The end of the saw blade must always project beyond the workpiece over the entire blade stroke.



WARNING

Risk of injury! Caused by the chuck / accessory tool retaining mechanism

- ▶ Always hold the power tool securely with both hands on the grips provided. Never use the power tool without a fully functional hand guard.



Note

The power tool must be pressed against the workpiece until the AVR contact shoe makes firm contact. This helps ensure maximum safety and good performance.

- ▶ Pull the battery out of the product to the rear.

5.2 Removing the battery 3

1. Press the two release buttons and hold them in the pressed position.
2. Pull the battery out of the product to the rear.

5.3 Fitting the saw blade 4



Note

Use only saw blades equipped with a 1/2" connection end.

1. Engage the transport lock.
2. Check that the connection end of the accessory tool is clean and lightly greased. Clean it and grease it if necessary.
3. Turn the chuck locking sleeve counterclockwise and hold it in this position.
4. Push the saw blade into the chuck from the front end of the tool.
5. Release the locking sleeve and allow it to click back and engage in its original position.
6. Grip and pull the saw blade to check that it is locked in position.

5.4 Removing the saw blade 5

1. Engage the transport lock.
2. Turn the chuck locking sleeve counterclockwise and hold it in this position.
3. Pull the blade forward out of the chuck.
4. Release the locking sleeve and allow it to move back to its original position.

5.5 Inserting the battery 6



WARNING

Electrical hazard! Risk of short circuiting.

- ▶ Before inserting the battery, check to ensure that the battery terminals and the contacts on the reciprocating saw are free from foreign objects.



WARNING

Risk of injury! Hazard presented by a falling battery.

- ▶ A falling battery may present a risk of injury to yourself and others. Check that the battery is securely seated in the reciprocating saw.

- ▶ Push the battery into the product from the rear as far as it will go and until it is heard to engage with a double click.

5.6 Switching on

1. Disengage the transport lock.
2. Press the control switch.

5.7 Switching off



WARNING

Risk of injury! Caused by the saw continuing to run.

- ▶ Do not lift the product away from the workpiece until it has stopped completely.
- ▶ Wait until the product stops completely before you lay it down.

1. Release the control switch.
2. Engage the transport lock.

5.8 Plunge cutting 7



WARNING

Risk of injury! Risk of kickback.

- ▶ Apply the appropriate safety measures at the rear of the workpiece when plunge sawing. Use only suitable saw blades (length as short as possible).



Note

Use the plunge cutting technique only on soft materials and with short saw blades. The product can be used in one of two plunge cutting positions: in the normal position or in the reversed position.

1. Bring the forward edge of the AVR contact shoe into contact with the workpiece.
2. Disengage the transport lock.
3. Press the control switch.
4. Press the forward edge of the contact shoe against the workpiece and begin the plunge action by slowly increasing the angle of attack.



Note

To prevent stalling, it is important that the product is running before the saw blade is brought into contact with the surface.

5. Once the saw blade has penetrated right through the material, bring the product into the normal working position (AVR contact shoe flush with the workpiece) and then continue sawing along the cutting line.

5.9 Changing the AVR contact shoe 8



Note

The AVR contact shoe can be changed when required.

1. Engage the transport lock.
2. Remove the saw blade.
3. Pull the rectangular plastic pin forward.



Note

It is located between the two AVR contact shoe guide pins.

4. Pull the AVR contact shoe out.
5. Press the rectangular plastic pin back into the original position.
6. Grease the AVR contact shoe lightly and insert it fully in the guides.
7. Check that the contact shoe has engaged.

6 Care, maintenance, transport and storage

6.1 Care of the reciprocating saw



WARNING

Electrical hazards. Improper repairs to electrical parts may lead to serious injuries.

- ▶ Electrical parts may be repaired only by trained electrical specialists.

- ▶ **Keep the product, especially its grip surfaces, clean and free from oil and grease. Do not use cleaning agents containing silicone.**
- ▶ Never operate the product when the air vents are blocked. Clean the air vents carefully using a dry brush. Do not allow foreign objects to enter the interior of the product.
- ▶ Clean the outside of the product at regular intervals with a slightly damp cloth. Do not use a spray, steam pressure cleaning equipment or running water for cleaning.



Note

To help ensure safe and reliable operation, use only genuine Hilti spare parts and consumables. Spare parts, consumables and accessories approved by Hilti for use with the product can be found at your local **Hilti Center** or online at: **www.hilti.com**

6.2 Transport and storage

Transport



CAUTION

Inadvertent starting during transport. Uncontrolled starting during transport may occur if the battery is fitted, thereby resulting in damage to the tool.

- ▶ Always remove the battery before transporting the tool.

- Remove the battery.
- Transport the tool and battery individually packaged.
- Never transport batteries in bulk form (loose, unprotected).
- Check tools and batteries for damage before use after long periods of transport.

Storage



CAUTION

Inadvertent damage caused by defective battery. A leaking battery may damage the tool.

- ▶ Always remove the battery before storing the tool.

- Store the tool and battery in a place that is as cool and dry as possible.
- Never store batteries in direct sunlight, on heating units or behind a window pane.
- Store the tool and batteries in a place where they cannot be accessed by children or unauthorized persons.
- Check the tool and batteries for damage before use after long periods of storage.

6.3 Checks after care and maintenance work

- ▶ After carrying out care and maintenance, check that all protective and safety devices are fitted and that they function faultlessly.

7 Troubleshooting

- ▶ If the trouble you are experiencing is not listed in this table or you are unable to remedy the problem by yourself, please contact **Hilti Service**.

7.1 The reciprocating saw is not operational.

Malfunction	Possible cause	Action to be taken
The LEDs indicate nothing.	The battery is not fully inserted.	▶ Push the battery in until it engages with a double click.
	The battery is empty.	▶ Charge the battery.
	The transport lock is engaged.	▶ Disengage the transport lock.
1 LED blinks.	The battery is discharged.	▶ Change the battery and charge the empty battery.
	The battery is too hot or too cold.	▶ Bring the battery to the recommended working temperature.

7.2 The reciprocating saw is operational.

Trouble or fault	Possible cause	Action to be taken
The tool does not achieve full power.	The control switch is not fully pressed.	▶ Press the control switch fully.
	The battery is discharged.	▶ Change the battery and charge the empty battery.
The saw blade can't be removed from the chuck.	The locking sleeve is not turned as far as it will go.	▶ Turn the locking sleeve as far as it will go and remove the saw blade.

8 Disposal



WARNING

Risk of injury. Hazards presented by improper disposal.

- ▶ Improper disposal of the equipment may have the following consequences: The burning of plastic components generates toxic fumes which may present a health hazard. Batteries may explode if damaged or exposed to very high temperatures, causing poisoning, burns, acid burns or environmental pollution. Careless disposal may permit unauthorized and improper use of the equipment. This may result in serious personal injury, injury to third parties and pollution of the environment.
- ▶ Dispose of defective batteries right away. Keep them out of reach of children. Do not disassemble or incinerate the batteries.
- ▶ Batteries that have reached the end of their life must be disposed of in accordance with national regulations or returned to **Hilti**.

 Most of the materials from which **Hilti** tools and appliances are manufactured can be recycled. The materials must be correctly separated before they can be recycled. In many countries, your old tools, machines or appliances can be returned to **Hilti** for recycling. Ask **Hilti** Service or your Hilti representative for further information.

9 Manufacturer's warranty

- ▶ Please contact your local **Hilti** representative if you have questions about the warranty conditions.



Hilti Corporation

LI-9494 Schaan

Tel.: +423/234 21 11

Fax: +423/234 29 65

www.hilti.com



408058