

# HILTI

**TE 60-AVR**  
**TE 60-ATC/AVR**

English





# 1 Information about the documentation



## 1.1 About this documentation

- Read this documentation before initial operation or use. This is a prerequisite for safe, trouble-free handling and use of the product.
- Observe the safety instructions and warnings in this documentation and on the product.
- Always keep the operating instructions with the product and make sure that the operating instructions are with the product when it is given to other persons.

## 1.2 Explanation of symbols used



### 1.2.1 Warnings

Warnings alert persons to hazards that may occur when handling or using the product. The following signal words are used in combination with a symbol:

|   |   |
|---|---|
|  | <b>DANGER!</b> Draws attention to an imminent hazard that will lead to serious personal injury or fatality.                       |
|  | <b>WARNING!</b> Draws attention to a potential hazard that could lead to serious personal injury or fatality.                     |
|  | <b>CAUTION!</b> Draws attention to a potentially dangerous situation that could lead to minor personal injury or material damage. |



### 1.2.2 Symbols in the documentation

The following symbols are used in this document:

|   |   |
|---|---|
|  | Read the operating instructions before use        |
|  | Instructions for use and other useful information |

### 1.2.3 Symbols in the illustrations









The following symbols are used in illustrations:

|   |  |
|---|--|
|  | These numbers refer to the corresponding illustrations found at the beginning of these operating instructions.                                       |
| 3   | The numbering reflects the sequence of operations shown in the illustrations and may deviate from the steps described in the text.                   |
|  | Item reference numbers are used in the <b>overview illustration</b> and refer to the numbers used in the key in the <b>product overview</b> section. |
|  | This symbol is intended to draw special attention to certain points when handling the product.   |

## 1.3 Product-dependent symbols

### 1.3.1 Symbols on the product

The following symbols are used on the product:

|   |  |
|---|--|
|  | Drilling without hammering action                |
|  | Drilling with hammering action (hammer drilling) |
|  | Chiseling  |
|  | Chisel positioning                               |
|  | Forward / reverse                                |
|  | Protection class II (double-insulated)           |
|  | Protective earth / ground (only TE 60-AVR)       |
|  | Diameter   |
| $n_0$   | Rated speed under no load                        |
| /min  | Revolutions per minute                           |

## 1.4 Product information

Hilti products are designed for professional use and may be operated, serviced and maintained only by trained, authorized personnel. This personnel must be informed of any particular hazards that may be encountered. The product and its ancillary equipment may present hazards when used incorrectly by untrained personnel or when used not as directed.

The type designation and serial number are printed on the type identification plate.

- ▶ Write down the serial number in the table below. You will be required to state the product details when contacting Hilti Service or your local Hilti organization to inquire about the product.

### Product information

|             |               |
|-------------|---------------|
| Combihammer | TE 60-ATC/AVR |
| Generation  | 04            |
| Serial no.  |               |

## 1.5 Declaration of conformity

We declare, on our sole responsibility, that the product described here complies with the applicable directives and standards. A copy of the declaration issued by the certification department can be found at the end of this documentation.

The technical documentation is filed and stored here:

**Hilti** Entwicklungsgesellschaft mbH | Tool Certification | Hiltistrasse 6 | 86916 Kaufering, Germany

## 2 Safety

### 2.1 General power tool safety warnings

#### ⚠ WARNING

**Read all safety warnings and all instructions.** Failure to follow the warnings and instructions may result in electric shock, fire and/or serious injury.

**Save all warnings and instructions for future reference.**

#### Work area safety

- ▶ **Keep work area clean and well lit.** Cluttered or dark areas invite accidents.
- ▶ **Do not operate power tools in explosive atmospheres, such as in the presence of flammable liquids, gases or dust.** Power tools create sparks which may ignite the dust or fumes.
- ▶ **Keep children and bystanders away while operating a power tool.** Distractions can cause you to lose control.

#### Electrical safety

- ▶ **Power tool plugs must match the outlet. Never modify the plug in any way. Do not use any adapter plugs with earthed (grounded) power tools.** Unmodified plugs and matching outlets will reduce risk of electric shock.
- ▶ **Avoid body contact with earthed or grounded surfaces, such as pipes, radiators, ranges and refrigerators.** There is an increased risk of electric shock if your body is earthed or grounded.
- ▶ **Do not expose power tools to rain or wet conditions.** Water entering a power tool will increase the risk of electric shock.
- ▶ **Do not abuse the cord. Never use the cord for carrying, pulling or unplugging the power tool. Keep cord away from heat, oil, sharp edges or moving parts.** Damaged or entangled cords increase the risk of electric shock.
- ▶ **When operating a power tool outdoors, use an extension cord suitable for outdoor use.** Use of a cord suitable for outdoor use reduces the risk of electric shock.
- ▶ **If operating a power tool in a damp location is unavoidable, use a residual current device (RCD) protected supply.** Use of an RCD reduces the risk of electric shock.

#### Personal safety

- ▶ **Stay alert, watch what you are doing and use common sense when operating a power tool. Do not use a power tool while you are tired or under the influence of drugs, alcohol or medication.** A moment of inattention while operating power tools may result in serious personal injury.
- ▶ **Use personal protective equipment. Always wear eye protection.** Protective equipment such as dust mask, non-skid safety shoes, hard

hat, or hearing protection used for appropriate conditions will reduce personal injuries.

- ▶ **Prevent unintentional starting. Ensure the switch is in the off-position before connecting to power source, picking up or carrying the tool.** Carrying power tools with your finger on the switch or energising power tools that have the switch on invites accidents.
- ▶ **Remove any adjusting key or wrench before turning the power tool on.** A wrench or a key left attached to a rotating part of the power tool may result in personal injury.
- ▶ **Do not overreach. Keep proper footing and balance at all times.** This enables better control of the power tool in unexpected situations.
- ▶ **Dress properly. Do not wear loose clothing or jewellery. Keep your hair, clothing and gloves away from moving parts.** Loose clothes, jewellery or long hair can be caught in moving parts.
- ▶ **If devices are provided for the connection of dust extraction and collection facilities, ensure these are connected and properly used.** Use of dust collection can reduce dust-related hazards.

#### **Power tool use and care**

- ▶ Do not force the power tool. Use the correct power tool for your application. The correct power tool will do the job better and safer at the rate for which it was designed.
- ▶ **Do not use the power tool if the switch does not turn it on and off.** Any power tool that cannot be controlled with the switch is dangerous and must be repaired.
- ▶ **Disconnect the plug from the power source from the power tool before making any adjustments, changing accessories, or storing power tools.** Such preventive safety measures reduce the risk of starting the power tool accidentally.
- ▶ **Store idle power tools out of the reach of children and do not allow persons unfamiliar with the power tool or these instructions to operate the power tool.** Power tools are dangerous in the hands of untrained users.
- ▶ **Maintain power tools. Check for misalignment or binding of moving parts, breakage of parts and any other condition that may affect the power tool's operation. If damaged, have the power tool repaired before use.** Many accidents are caused by poorly maintained power tools.
- ▶ **Keep cutting tools sharp and clean.** Properly maintained cutting tools with sharp cutting edges are less likely to bind and are easier to control.
- ▶ **Use the power tool, accessories and tool bits etc. in accordance with these instructions, taking into account the working conditions and the work to be performed.** Use of the power tool for operations different from those intended could result in a hazardous situation.

## Service

- ▶ **Have your power tool serviced by a qualified repair person using only identical replacement parts.** This will ensure that the safety of the power tool is maintained.

## 2.2 Hammer safety warnings

- ▶ **Wear ear protectors.** Exposure to noise can cause hearing loss.
- ▶ **Use auxiliary handles, if supplied with the tool.** Loss of control can cause personal injury.
- ▶ **Hold power tool by insulated gripping surfaces, when performing an operation where the cutting accessory may contact hidden wiring or its own cord.** Cutting accessory contacting a "live" wire may make exposed metal parts of the power tool "live" and could give the operator an electric shock.

## 2.3 Additional safety instructions for rotary hammer

### Personal safety

- ▶ Use the product only when it is in technically faultless condition.
- ▶ Never tamper with or modify the power tool in any way.
- ▶ Use the auxiliary grips supplied with the tool. Loss of control can cause personal injury.
- ▶ Apply appropriate safety measures at the opposite side of the workpiece in work that involves breaking through. Parts breaking away could fall out and / or fall down causing injury to other persons.
- ▶ Always hold the power tool with both hands on the grips provided. Keep the grips clean and dry.
- ▶ Hold the power tool by the insulated gripping surfaces when performing work in which the accessory tool might come into contact with concealed wiring. If the accessory tool comes into contact with a live wire, metal parts of the power tool can also become live, resulting in an electric shock.
- ▶ Avoid touching rotating parts – risk of injury!
- ▶ Wear suitable protective glasses, a hard hat, ear defenders, protective gloves and light respiratory protection while using the power tool.
- ▶ Wear protective gloves also when changing the accessory tool. Touching the accessory tool presents a risk of injury (cuts or burns).
- ▶ Wear eye protection. Flying fragments present a risk of injury to the body and eyes.
- ▶ Before starting work, check the hazard class of the dust that will be produced when working. Use an industrial vacuum cleaner with an officially approved protection class in compliance with the locally applicable dust protection regulations. Dust from materials such as lead-based paint, certain types of wood and concrete/masonry/stone containing quartz, minerals or metal can be harmful to health.

- ▶ Make sure that the workplace is well ventilated and, where necessary, wear a respirator appropriate for the type of dust generated. Contact with or inhalation of the dust can cause allergic reactions and/or respiratory or other diseases to the operator or bystanders. Certain kinds of dust such as oakwood and beechwood dust are classified as carcinogenic, especially in conjunction with additives for wood conditioning (chromate, wood preservative). Only specialists are permitted to handle material containing asbestos.
- ▶ Take breaks and do physical exercises to improve the blood circulation in your fingers. Exposure to vibration during long periods of work can lead to disorders of the blood vessels and nervous system in the fingers, hands and wrists.

### **Electrical safety**

- ▶ Before beginning work, check the working area for concealed electric cables, gas pipes and water pipes. External metal parts of the power tool can become live, presenting a risk of electric shock, if you accidentally damage an electric cable.

### **Power tool use and care**

- ▶ Immediately switch off the power tool if the accessory tool jams. The power tool might twist off-line.
- ▶ Wait until the power tool stops completely before you lay it down.







### 3 Description

#### 3.1 Overview of the product

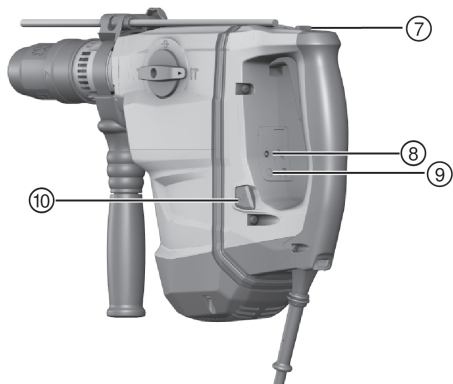
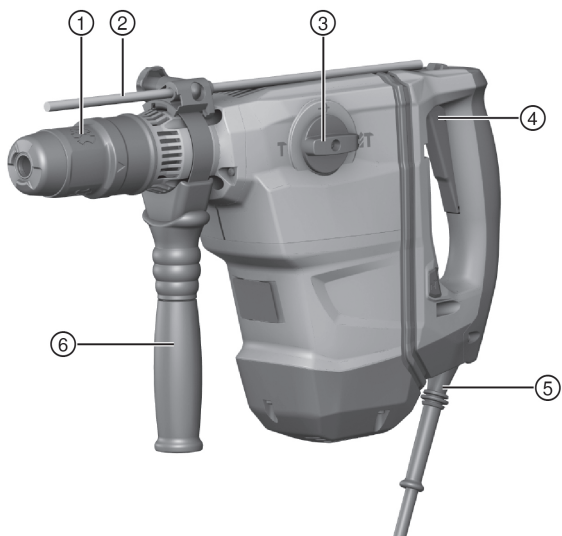

- |                            |                                       |
|----------------------------|---------------------------------------|
| ① Chuck                    | ⑦ Lockbutton for continuous operation |
| ② Depth gauge              | ⑧ Service indicator                   |
| ③ Function selector switch | ⑨ Reduced-power indicator             |
| ④ Control switch           | ⑩ Power reduction button (50% power)  |
| ⑤ Supply cord              |                                       |
| ⑥ Side handle              |                                       |

### 3.2 Version with detachable supply cord

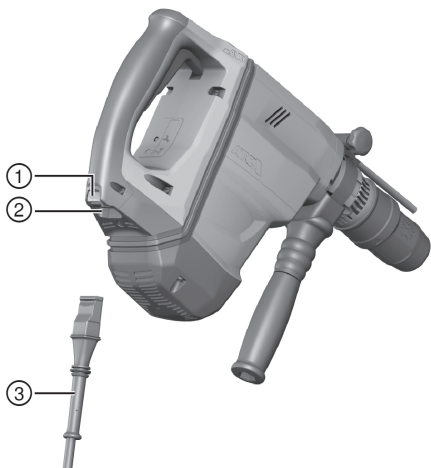

- |                              |   |
|------------------------------|---|
| ① Lockbutton                 | ③ Supply cord with keyed, releasable plug connector |
| ② Connector on electric tool |   |

### 3.3 Intended use

The product described is an electrically-powered combihammer with pneumatic hammering mechanism. It is designed for drilling in concrete, masonry, wood and metal. The product can also be used for light to medium-duty chiseling on masonry and surface finishing work on concrete.

Under certain conditions, the product may also be suitable for stirring / mixing.

- ▶ The power tool may be operated only when connected to a power supply providing a voltage and frequency in compliance with the information given on its type plate.

### 3.4 Possible misuse

- This product is not suitable for working on hazardous materials.
- This product is not suitable for working in a damp environment.

### 3.5 Undercut anchors

The product is suitable for setting undercut anchors. Use only suitable setting tools.

Detailed information on this topic can be obtained at your local **Hilti** Center.

### 3.6 Active Torque Control

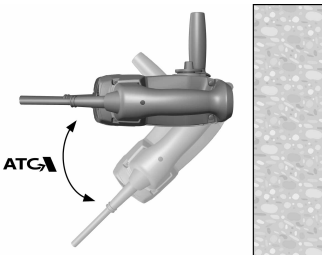

The tool is equipped with a mechanical slip clutch and an Active Torque Control (ATC) system.

This system provides additional drilling safety and convenience as it causes rapid shutdown upon sudden rotation of the power tool about the drill bit axis. This may occur, for example, when the drill bit sticks due to hitting a rebar or when the drill bit is tilted unintentionally.

Always choose a working position in which the body of the power tool, when running in a forward direction (clockwise), is free to rotate in a counterclockwise direction (as seen by the operator). When running in reverse, the tool reacts to sudden clockwise rotation. If rotational movement is not possible, the ATC system cannot react.

### 3.7 Active Vibration Reduction

The tool is equipped with an Active Vibration Reduction (AVR) system which reduces vibration noticeably.

### 3.8 Quick-release chuck (accessory)

The quick-release chuck makes it possible to change accessory tools quickly, without need for a chuck key (keyless system). It is suitable for accessory tools with a cylindrical or hexagonal shank, such as drill bits for wood and metal, or mixing paddles, which are used in the rotary-only mode (without hammering action)  $\frac{1}{2}$ .

### 3.9 Service indicator

The product is equipped with a service indicator LED.

#### 3.9.1 Service indicator status

| Status                        | Meaning  |
|-------------------------------|--|
| The service indicator lights. | <ul style="list-style-type: none"><li>• End of service interval – servicing is due.</li></ul>            |
| The service indicator blinks. | <ul style="list-style-type: none"><li>• Have the combihammer repaired by <b>Hilti Service</b>.</li></ul> |

#### 3.10 Items supplied

Combihammer, side handle, operating instructions.

### 4 Technical data

When powered by a generator or transformer, the generator or transformer's power output must be at least twice the rated input power shown on the rating plate of the power tool. The operating voltage of the transformer or generator must always be within +5% and -15% of the rated voltage of the power tool. The information given applies to a rated voltage of 120 V. The data may vary in the event of deviations from the rated voltage and for country-specific versions. Please refer to the power tool's type identification plate for details of its voltage, frequency, current and input power ratings.

|  | TE 60-AVR                                       | TE 60-ATC/AVR                                   |
|--|---|---|
| <b>Rated current input</b>                                       | 13 A  | 13 A  |
| <b>AC frequency</b>  | 60 Hz   | 60 Hz   |
| <b>Weight</b>  | 15.0 lb<br>(6.8 kg)                             | 17.2 lb<br>(7.8 kg)                             |
| <b>Single impact energy in accordance with EPTA procedure 05</b> | 7.8 J   | 7.8 J   |
| <b>Ø Hammer drill bits</b>                                       | 1/2 in ... 1 9/16 in<br>(13 mm ... 39.7 mm)     | 1/2 in ... 1 9/16 in<br>(13 mm ... 39.7 mm)     |
| <b>Ø Breach bits</b>   | 1 9/16 in ... 3 1/8 in<br>(39.7 mm ... 79.4 mm) | 1 9/16 in ... 3 1/8 in<br>(39.7 mm ... 79.4 mm) |
| <b>Ø Percussion core bits</b>                                    | 1 3/4 in ... 4 in<br>(44.4 mm ... 100 mm)       | 1 3/4 in ... 4 in<br>(44.4 mm ... 100 mm)       |
| <b>Ø PCM diamond core bits</b>                                   | •/•   | 1 1/2 in ... 4 in<br>(38 mm ... 100 mm)         |
| <b>Ø Drill bits for metal</b>                                    | 0 in ... 1/2 in<br>(0 mm ... 13 mm)             | 0 in ... 1/2 in<br>(0 mm ... 13 mm)             |

|                       | TE 60-AVR                                      | TE 60-ATC/AVR                                  |
|-----------------------|--|--|
| ∅ Drill bits for wood | 13/32 in ... 1 1/4 in<br>(10.3 mm ... 31.8 mm) | 13/32 in ... 1 1/4 in<br>(10.3 mm ... 31.8 mm) |
| Chuck                 | TE-Y   | TE-Y   |

## 5 Operation

### 5.1 Preparations at the workplace



#### CAUTION

**Risk of injury!** Inadvertent starting of the product.

- ▶ Unplug the supply cord before making adjustments to the power tool or before changing accessories.

Observe the safety instructions and warnings in this documentation and on the product.

#### 5.1.1 Fitting the side handle

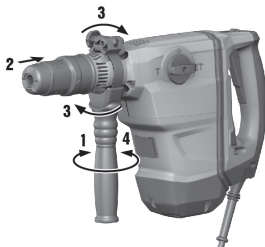
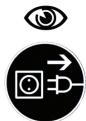

1. Release the side handle clamping band by turning the handle grip.
2. Slide the side handle clamping band over the chuck from the front and into the recess provided.
3. Bring the side handle into the desired position.
4. Tighten the side handle clamping band by turning the handle grip.

## 5.1.2 Fitting the depth gauge (optional)

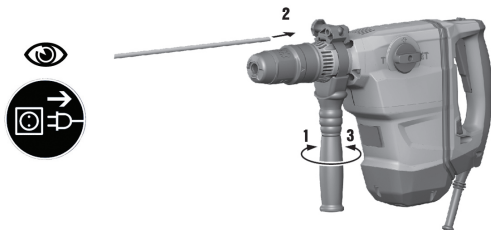

1. Release the side handle clamping band by turning the handle grip.
2. Slide the depth gauge from the front into the 2 guide holes provided.
3. Tighten the side handle clamping band by turning the handle grip.

## 5.1.3 Setting the power level (optional)

TE 60-ATC/AVR



### Note

After the supply cord is connected to the AC supply, the product is always set by default to full power.

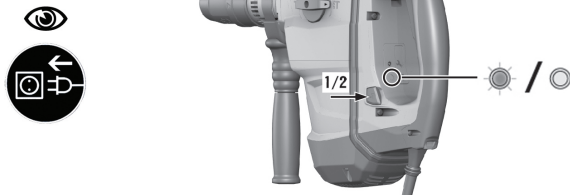

1. Press the power reduction button. The product runs at reduced power (50 %).
  - ◁ The reduced-power LED lights.
2. Press the power reduction button again. The product runs at full power.
  - ◁ The reduced-power LED goes out.



### 5.1.4 Fitting the accessory tool

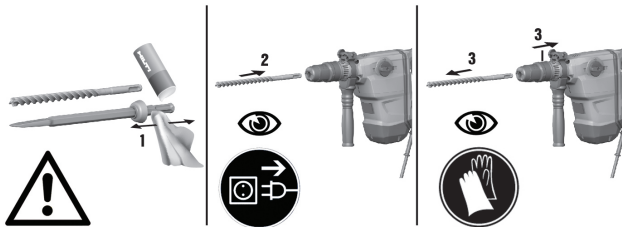

1. Apply a little grease to the connection end of the accessory tool.
  - ◁ Use only the recommended grease supplied by **Hilti**. Using the wrong grease can result in damage to the tool.
2. Push the accessory tool into the chuck as far as it will go (until it engages).
3. After fitting the accessory tool, grip it and pull it in order to check that it is securely engaged.
  - ◁ The product is ready for use.

### 5.1.5 Removing the accessory tool



#### CAUTION

**Risk of injury!** The accessory tool gets hot during use.

- ▶ Wear protective gloves when changing the accessory tool.
- ▶ Do not place the hot accessory tool on readily flammable materials.

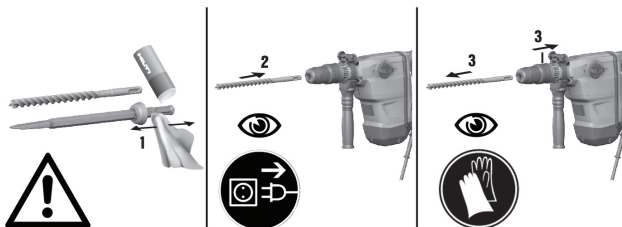

- ▶ Pull the chuck back as far as it will go and remove the accessory tool.

## 5.2 Types of work

### CAUTION

**Risk of injury!** Loss of control over the combihammer.

- ▶ Check that the side handle is fitted correctly and tightened securely. Check that the clamping band is engaged in the groove provided on the tool.

Observe the safety instructions and warnings in this documentation and on the product.

### 5.2.1 Drilling with hammering action (hammer drilling)

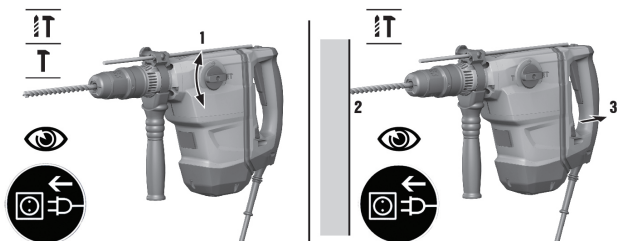

1. Set the function selector switch to this symbol: .
2. Set the desired power level.
3. Press the drill bit against the work surface.
4. Press the control switch.
  - ◁ The product starts.

### 5.2.2 Drilling without hammering

#### Note

Drilling without hammering action is possible when accessory tools with a special connection end are used. Accessory tools of this kind are available from **Hilti**. Alternatively, when the keyless quick-release chuck is fitted, smooth-shank drill bits for wood or steel, for example, can be used to drill without hammering.

- ▶ Set the function selector switch to this symbol: .

### 5.2.3 Mixing



#### Note

Use the mixing paddle only with the quick-release chuck.  
Use the mixing paddle only when the reduced power (50 %) setting is active.

1. Insert the quick-release chuck in the power tool's chuck.
2. Fit the mixing paddle into the quick-release chuck.
3. Set the function selector switch to this symbol: .
4. Press the power reduction (50 %) button.
  - ◁ The product is ready for use.

### 5.3 Chisel positioning



#### CAUTION

**Risk of injury!** Loss of control over the chisel direction.



- ▶ Do not operate the tool when the selector switch is set to “Chisel positioning”. Turn the function selector switch until it engages in the “Chiseling” position.

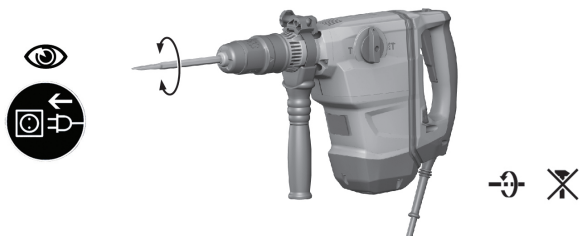

#### Note

The chisel can be adjusted to 24 different positions (in 15° increments). This ensures that flat chisels and shaped chisels can always be set to the optimum working position.



1. Set the function selector switch to this symbol: .
2. Rotate the chisel to the desired position.
3. Set the function selector switch to this symbol:  until it engages.
  - ◁ The product is ready for use.

### 5.3.1 Chiseling

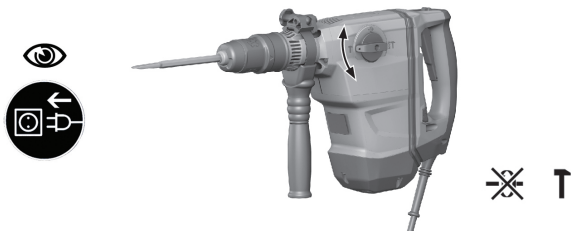

- ▶ Set the function selector switch to this symbol: **T**.

### 5.3.2 Switch sustained operation on and off



#### Note

When chiseling, the control switch can be locked in the “on” position.

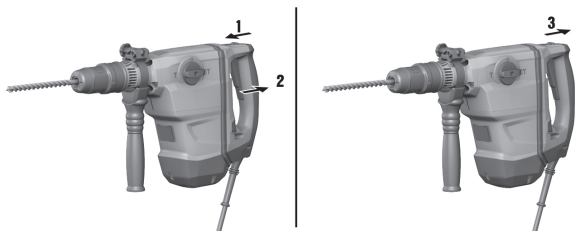

1. Push the lockbutton for continuous operation forward.
2. Press the control switch fully.
  - ◁ The product then runs in sustained operating mode.
3. Push the lockbutton for continuous operation back.
  - ◁ The product switches off.

## 6 Care and maintenance



### WARNING

**Danger of electric shock!** Carrying out care and maintenance while the supply cord is connected to the power outlet presents a risk of serious injuries including burns.

- ▶ Always unplug the supply cord before carrying out all care and maintenance tasks.

### Care

- Carefully remove any dirt that may be adhering to parts.
- Clean the air vents carefully with a dry brush.
- Use only a slightly damp cloth to clean the casing. Do not use cleaning agents containing silicone as these may attack the plastic parts.

### Maintenance



### WARNING

**Danger of electric shock!** Improper repairs to electrical components may lead to serious injuries including burns.

- ▶ Repairs to the electrical section of the tool or appliance may be carried out only by trained electrical specialists.
- 
- Check all visible parts and controls for signs of damage at regular intervals and make sure that they all function correctly.
  - Do not operate the electric tool if damaged or if its parts malfunction. Have the tool repaired by **Hilti Service** immediately.
  - After cleaning and maintenance, fit all guards or protective devices and check that they function correctly.



### Note

To help ensure safe and reliable operation, use only genuine Hilti spare parts and consumables. Spare parts, consumables and accessories approved by Hilti for use with the product can be found at your local **Hilti Center** or online at: **[www.hilti.com](http://www.hilti.com)**

## 6.1 Connecting the detachable supply cord



### CAUTION

**Risk of injury!** Due to leakage current as a result of dirty contacts.

- ▶ Connect the detachable electric connector to the electric tool only when it is clean and dry and when the supply cord is unplugged from the power outlet.
- 
1. Push the keyed, detachable electric plug connector into the socket as far as it will go, until it is heard to engage.
  2. Plug the supply cord into the power outlet.

## 6.2 Disconnecting the detachable supply cord

1. Unplug the supply cord from the power outlet.
2. Press the release button and pull the keyed, detachable electric plug connector out of the socket.
3. Pull the supply cord connector out of the power tool.

## 7 Transport and storage

- Do not transport electric tools with accessory tools fitted.
- Always unplug the supply cord before storing an electric tool or appliance.
- Store tools and appliances in a dry place where they cannot be accessed by children or unauthorized persons.
- Check electric tools or appliances for damage after long periods of transport or storage.

## 8 Troubleshooting

If the trouble you are experiencing is not listed in this table or you are unable to remedy the problem by yourself, please contact **Hilti** Service.

| Trouble or fault                      | Possible cause   | Action to be taken   |
|---------------------------------------|--|--|
| No hammering action.                  | The tool is too cold.  | ▶ Bring the tip of the accessory tool into contact with the working surface, switch the power tool on and allow it to run. If necessary, repeat the procedure until the hammering mechanism begins to operate. |
| The tool does not achieve full power. | The extension cord is too long and/or its gauge is inadequate. | ▶ Use an extension cord of an approved length and/or of adequate gauge.  |
|                                       | The control switch is not fully pressed.                       | ▶ Press the control switch as far as it will go.   |
|                                       | The voltage provided by the electric supply is too low.        | ▶ Connect the combi-hammer to a different electric supply.   |

| <b>Trouble or fault</b>               | <b>Possible cause</b>  | <b>Action to be taken</b>  |
|---------------------------------------|--|--|
| The tool does not achieve full power. | The reduced-power (50% power) button is engaged.   | ▶ Press the reduced-power button.  |
| The drill bit does not rotate.        | The function selector switch is not correctly engaged, is set to “Chiseling” <b>T</b> , or is set to “Chisel positioning” <b>→</b> . | ▶ Move the function selector switch to the “Hammer drilling” <b>⚡</b> position while the motor is not rotating.                |
| The drill bit cannot be released.     | The chuck is not pulled back fully.  | ▶ Pull the chuck back as far as it will go and remove the accessory tool.  |
|                                       | The side handle is not fitted correctly.   | ▶ Release the side handle and refit it correctly so that the clamping band and side handle engage in the recess.               |
| The power tool doesn't start.         | Interruption in the electric supply.   | ▶ Plug in another electric tool or appliance and check whether it works.   |
|                                       | The electronic restart interlock is activated after an interruption in the electric supply.  | ▶ Switch the power tool off and then on again.   |
|                                       | The supply cord or plug is defective.  | ▶ Have the supply cord or the plug checked by a trained electrical specialist and replaced if necessary.                       |
|                                       | The detachable supply cord is not fitted correctly.  | ▶ Fit the detachable supply cord to the power tool correctly.  |
|                                       | Generator with sleep mode.   | ▶ Apply a load to the generator by connecting a second power consumer (e.g. worklight). Switch the tool off and then on again. |

| Trouble or fault              | Possible cause  | Action to be taken   |
|-------------------------------|---|--|
| The service indicator lights. | The carbon brushes are worn.                            | ▶ Have the power tool checked by a trained electrical specialist and the carbon brushes replaced if necessary. |
| The service indicator blinks. | Damage to the power tool or service limit time reached. | ▶ Have the product repaired by <b>Hilti Service</b> .  |

## 9 Disposal

 Most of the materials from which **Hilti** tools and appliances are manufactured can be recycled. The materials must be correctly separated before they can be recycled. In many countries, your old tools, machines or appliances can be returned to **Hilti** for recycling. Ask **Hilti Service** or your Hilti representative for further information.



- ▶ Disposal of electric tools or appliances together with household waste is not permissible.

## 10 Manufacturer's warranty

- ▶ Please contact your local **Hilti** representative if you have questions about the warranty conditions.



This Product is Certified  
Ce produit est homologué  
Producto homologado por  
Este produto está registrado





Hilti Corporation

LI-9494 Schaan

Tel.: +423/234 21 11

Fax: +423/234 29 65

[www.hilti.com](http://www.hilti.com)

Hilti = registered trademark of Hilti Corp., Schaan

Printed: 28.06.2017 | Doc-Nr: PUB / 5277966 / 000 / 01



20170511