

HILTI

PMA 31-G

English



1 Information about the documentation



1.1 About this documentation

- Read this documentation before initial operation or use. This is a prerequisite for safe, trouble-free handling and use of the product.
- Observe the safety instructions and warnings in this documentation and on the product.
- Always keep the operating instructions with the product and make sure that the operating instructions are with the product when it is given to other persons.

1.2 Explanation of symbols used



1.2.1 Warnings

Warnings alert persons to hazards that may occur when handling or using the product. The following signal words are used in combination with a symbol:

	DANGER! Draws attention to an imminent hazard that will lead to serious personal injury or fatality.
	WARNING! Draws attention to a potential hazard that could lead to serious personal injury or fatality.
	CAUTION! Draws attention to a potentially dangerous situation that could lead to minor personal injury or material damage.



1.2.2 Symbols in the documentation

The following symbols are used in this document:

	Read the operating instructions before use
	Instructions for use and other useful information

1.2.3 Symbols in the illustrations

The following symbols are used in illustrations:

	These numbers refer to the corresponding illustrations found at the beginning of these operating instructions.
3	The numbering reflects the sequence of operations shown in the illustrations and may deviate from the steps described in the text.
	Item reference numbers are used in the overview illustration and refer to the numbers used in the key in the product overview section.
	This symbol is intended to draw special attention to certain points when handling the product.

1.3 Product information

Hilti products are designed for professional use and may be operated, serviced and maintained only by trained, authorized personnel. This personnel must be informed of any particular hazards that may be encountered. The product and its ancillary equipment can present hazards if used incorrectly by untrained personnel or if used not in accordance with the intended use.

The type designation and serial number are stated on the rating plate.

- ▶ Write down the serial number in the table below. You will be required to state the product details when contacting Hilti Service or your local Hilti organization to inquire about the product.

Product information

Multi-line laser	PMA 31G
Generation	02
Serial no.	

2 Safety

2.1 General safety rules

- ▶ Check the condition of the tool before use. If damaged, have the tool repaired by **Hilti** Service.
- ▶ Do not render safety devices ineffective and do not remove information and warning notices.
- ▶ After falling from considerable height, the tool should be checked for correct, accurate operation.
- ▶ To avoid measurement errors, the receiving area must be kept clean.
- ▶ Handle the tool carefully.
- ▶ Allow the tool to dry before putting it into storage.

2.2 Electrical safety

- ▶ Keep the batteries out of reach of children.
- ▶ Do not allow the batteries to overheat and do not expose them to fire. The batteries may explode and release toxic substances.
- ▶ Do not charge the batteries.
- ▶ Do not solder the batteries into the tool.
- ▶ Do not discharge the batteries by short-circuiting. The batteries may get hot, presenting a risk of personal injury (burns).
- ▶ Do not attempt to open the batteries and do not subject them to excessive mechanical stress.

2.3 Electromagnetic compatibility

Although the device complies with the strict requirements of the applicable directives, **Hilti** cannot entirely rule out the possibility of interference to the device caused by powerful electromagnetic radiation, possibly leading to incorrect operation. Check the accuracy of the device by taking measurements by other means when working under such conditions, or if you are unsure. Likewise, **Hilti** cannot rule out the possibility of interference with other devices (e.g. aircraft navigation equipment).

WARNING! This is a Class A laser device in accordance with EN 55011. The device may cause radio interference in a domestic environment. In this case the operator may be required to take appropriate measures.

3 Description

3.1 PMA 31-G laser receiver

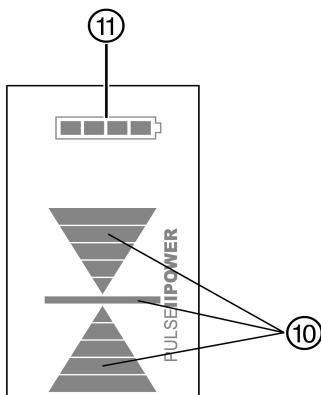
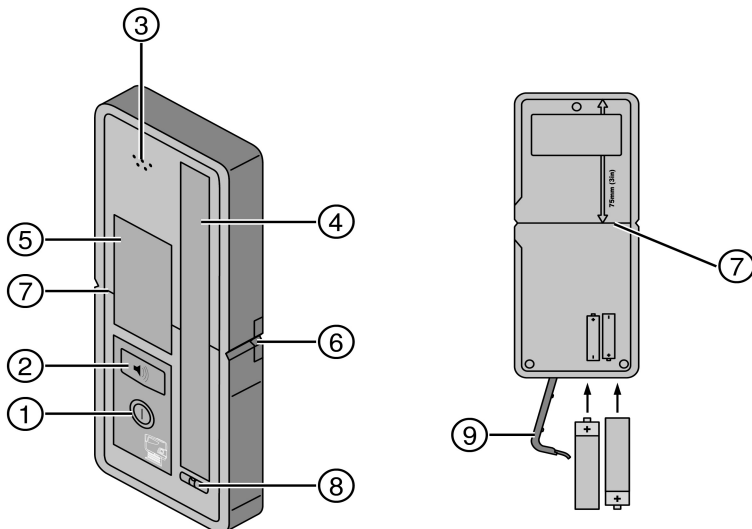

- | | |
|---------------------------------|--|
| ① On/off button | ⑦ Reference plane |
| ② Audible signal setting button | ⑧ Bubble level |
| ③ Signal tone aperture | ⑨ Battery compartment cover |
| ④ Receiving field | ⑩ Indication of the position of the receiver relative to the laser plane |
| ⑤ Display | ⑪ Battery status indicator |
| ⑥ Marking notch | |

3.2 Intended use

The tool is designed to detect laser beams from the PM 2-LG and PM 40-MG line lasers.

The tool and its ancillary equipment may present hazards when used incorrectly by untrained personnel or when used not as directed.

Modification of the tool is not permitted.

Observe the information printed in the operating instructions concerning operation, care and maintenance.

Take the influences of the surrounding area into account. Do not use the device where there is a risk of fire or explosion.

3.3 Items supplied

- 1 laser receiver
- 1 operating instructions
- 2 batteries
- 1 manufacturer's certificate

4 Technical data

4.1 Technical data

Operating range	2 m ...30 m
Laser plane display accuracy (at 10m)	±1 mm (± 0.4 in)
Receiving area	120 mm (5 in)
Center indication from top edge of casing	75 mm (3 in)
Receiver automatic power-off	When no beam is detected: 30 min.
Dimensions	160 mm X 67 mm X 27 mm (6.5" X 2.6" X 0.9")
Weight (including batteries)	0.25 kg (0.6 lbs)
Power source	2 AA batteries
Operating temperature	-20... +50 °C (-4 to 122°F)
Storage temperature	-30... +60 °C (-22 to 140°F)
Protection class	IP 56, in accordance with IEC 529

5 Operation

5.1 Switching on and off

- ▶ Press the on / off button to switch the tool on or off.

5.2 Working with the receiver

- ▶ The PMA 31 G receiver can be used at distances of up to 35 m (115 ft) from the laser tool. The laser beam is indicated visually and by a signal tone.

5.3 Working with the horizontal line

- ▶ Hold the PMA 31 G receiver in the laser beam with the receiving window at right angles to the projected plane of the line.



Note

Results may be inaccurate if the receiving window is not held at right angles to the projected plane of the line.

5.4 Working with the vertical line

1. Check that the vertical line is projected at right angles to the wall (or working surface).



Note

Results may be inaccurate if the vertical line is not projected at right angles to the wall or working surface.

2. Switch the PMA 31 G receiver on by pressing the on/off button .
3. Hold the PMA 31 G receiver in the laser beam with the receiving window at right angles to the projected plane of the line.



Note

Results may be inaccurate if the receiving window is not held at right angles to the projected plane of the line.

5.5 Adjusting the volume

- ▶ Set the desired volume level by pressing the audible signal adjustment button.

5.6 Cleaning and drying

- ▶ Blow dust off the surface.
- ▶ Do not touch the display or the receiving window with your fingers.
- ▶ Use only a soft, clean cloth to clean the tool. If necessary, moisten the cloth with a little alcohol or water.
- ▶ Observe the temperature limits when storing your equipment. This is particularly important in summer or winter if the equipment is kept inside a motor vehicle (-30°C to +60°C / -22°F to 140°F).

5.7 Hilti Calibration Service

We recommend that the tool is checked by the **Hilti** Calibration Service at regular intervals in order to verify its reliability in accordance with standards and legal requirements.

Use can be made of the **Hilti** Calibration Service at any time. Calibration at least once a year is recommended.

The **Hilti** Calibration Service provides confirmation that the tool is in conformance, on the day it is tested, with the specifications given in the operating instructions.

The tool will be readjusted if deviations from the manufacturer's specification are found.

After checking and adjustment, a calibration sticker applied to the tool and a calibration certificate provide written verification that the tool operates in accordance with the manufacturer's specification.

Calibration certificates are always required by companies certified according to ISO 900X.

Your local **Hilti** contact will be pleased to provide further information.

6 Transport and storage

6.1 Transport

- ▶ Use the **Hilti** shipping box or packaging of equivalent quality for transporting or shipping your equipment.



Note

The batteries must be insulated or removed from the tool before the tool is shipped or sent by mail.

6.2 Storage

- ▶ Remove the tool from its case if it has become wet.
- ▶ The tool, its carrying case and accessories should be cleaned and dried (at maximum 63 °C/145 °F).
- ▶ Repack the equipment only once it has dried completely and then store it in a dry place.

- ▶ Check the accuracy of the equipment before it is used after a long period of storage or transportation.

6.3 Transport and storage of cordless tools

Transport



CAUTION

Inadvertent starting during transport. Uncontrolled starting during transport may occur if the battery is fitted, thereby resulting in damage to the tool.

- ▶ Always remove the battery before transporting the tool.

- ▶ Remove the battery.
- ▶ Transport the tool and batteries individually packaged.
- ▶ Never transport batteries in bulk form (loose, unprotected).
- ▶ Check the tool and batteries for damage before use after long periods of transport.

Storage



CAUTION

Inadvertent damage caused by defective battery. A leaking battery may damage the tool.

- ▶ Always remove the battery before storing the tool.

- ▶ Store the tool and batteries in a place that is as cool and dry as possible.
- ▶ Never store batteries in direct sunlight, on heating units or behind a window pane.
- ▶ Store the tool and batteries in a place where they cannot be accessed by children or unauthorized persons.
- ▶ Check the tool and batteries for damage before use after long periods of storage.

7 Disposal

 Most of the materials from which **Hilti** tools and appliances are manufactured can be recycled. The materials must be correctly separated before they can be recycled. In many countries, your old tools, machines or appliances can be returned to **Hilti** for recycling. Ask **Hilti** Service or your Hilti representative for further information.



- ▶ Disposal of electric tools or appliances together with household waste is not permissible.

8 Manufacturer's warranty

- ▶ Please contact your local **Hilti** representative if you have questions about the warranty conditions.

9 Declaration of conformity

We declare, on our sole responsibility, that this product complies with the applicable directives and standards. It has been tested and approved for use together with the specified products.

10 FCC statement (applicable in US) / IC statement (applicable in Canada)

This device complies with Part 15 of the FCC Rules and CAN ICES-3 (B) / NMB-3 (B). Operation is subject to the following two conditions:

1. This device shall cause no harmful interference.
2. This device must accept any interference received, including interference that may cause undesired operation.



Note

Changes or modifications not expressly approved by **Hilti** may restrict the user's authorization to operate the equipment.



Hilti Corporation

LI-9494 Schaan

Tel.: +423/234 21 11

Fax: +423/234 29 65

www.hilti.com

Hilti = registered trademark of Hilti Corp., Schaan



20170331