

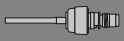









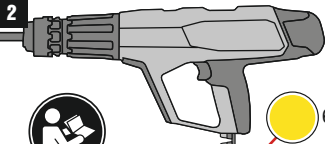

1	X-5-460 FIE-L 	X-5-460 FIE-XL 
	T: 20-140 mm	T: 20-200 mm

2



 6.8/11   DX 5-IE
 6.8/11   DX 460-IE
 6.8/11   DX 6-IE

DX 5-IE
 DX 460-IE
 DX 6-IE

3

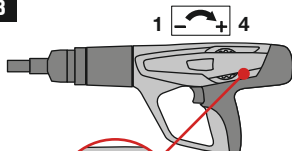

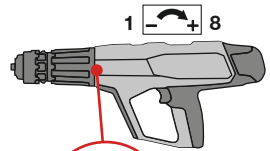

1 - 4
 DX 460-IE
 DX 5-IE

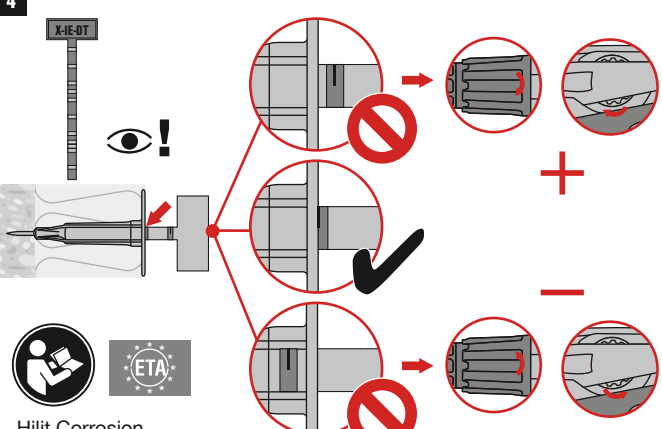

1 - 8
 DX 6-IE

4



 

Hilit Corrosion handbook / DFTM

5

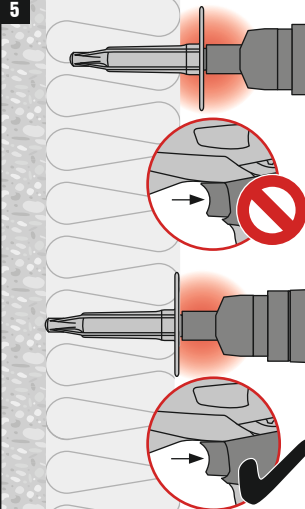

6

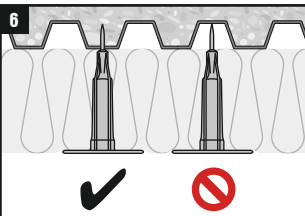

7

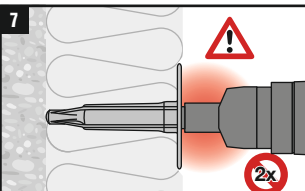

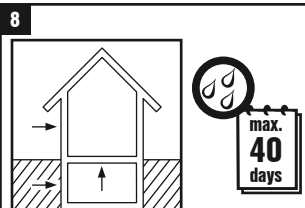

8





max. 40 days

Mineral wool  ✓

EPS  ✓

XPS  ✓

PIR  ✓

PUR  ✓

Soft core Multilayer  ✓
Core: mineral wool

Ø 60 mm

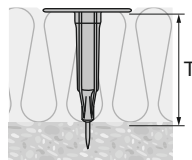

T (mm)	Designation	T (mm)	Designation
20	X-IE 6-20 DT	90	X-IE 6-90 DT
25	X-IE 6-25 DT	100	X-IE 6-100 DT
30	X-IE 6-30 DT	120	X-IE 6-120 DT
35	X-IE 6-35 DT	125	X-IE 6-125 DT
40	X-IE 6-40 DT	140	X-IE 6-140 DT
50	X-IE 6-50 DT	150	X-IE 6-150 DT
60	X-IE 6-60 DT	160	X-IE 6-160 DT
70	X-IE 6-70 DT	175	X-IE 6-175 DT
75	X-IE 6-75 DT	180	X-IE 6-180 DT
80	X-IE 6-80 DT	200	X-IE 6-200 DT

Stiff core Multilayer  ✓
Core: EPS, XPS, PIR, PUR

Ø 60 mm

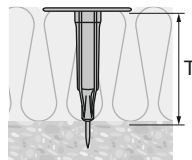

T (mm)	Designation	T (mm)	Designation
14-17	X-IE 6-20 DT	84-87	X-IE 6-90 DT
19-22	X-IE 6-25 DT	94-97	X-IE 6-100 DT
24-27	X-IE 6-30 DT	114-117	X-IE 6-120 DT
29-32	X-IE 6-35 DT	119-122	X-IE 6-125 DT
34-37	X-IE 6-40 DT	134-137	X-IE 6-140 DT
44-47	X-IE 6-50 DT	144-147	X-IE 6-150 DT
54-57	X-IE 6-60 DT	154-157	X-IE 6-160 DT
64-67	X-IE 6-70 DT	169-172	X-IE 6-175 DT
69-72	X-IE 6-75 DT	174-177	X-IE 6-180 DT
74-77	X-IE 6-80 DT	194-197	X-IE 6-200 DT

Ø 20 mm

